

Product guide

Solutions for Air Handling Units

Technology and expertise
for indoor air quality and
energy saving

The CAREL logo is a red oval with the word "CAREL" in white, bold, sans-serif capital letters. The letters "A" and "E" have horizontal lines underneath them.

CAREL

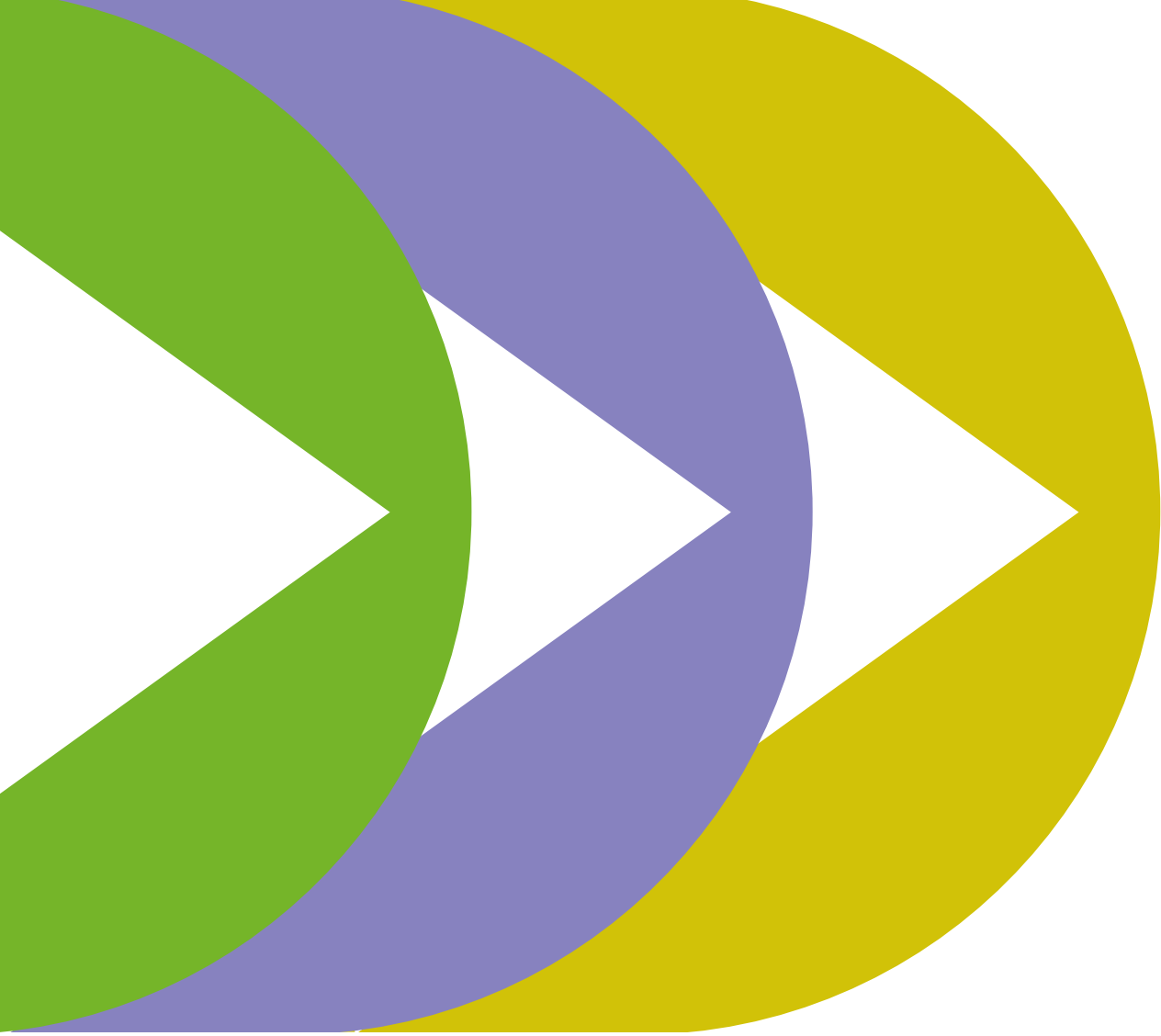

We've got a new idea of future and we want to contribute to fulfilling it with real action, to meet a demand for sustainable development that can wait no longer.





DRIVEN BY
THE FUTURE

Sustainability in action

“We recognize environmental issues as a corporate priority”

Francesco Nalini, CAREL Group CEO

The company's claim, “driven by the future”, perfectly sums up the CAREL model, representing the starting point and the final goal that together encompass the process of designing, manufacturing and marketing our products and systems. Indeed, CAREL's products are born from the hope that a better future for the planet and its people is possible. It is with this awareness that CAREL intends to follow a path to achieve, day after day, concrete and measurable sustainability objectives, for the present and future generations.

An innovative consulting and technological partner, CAREL anticipates market demands, proposing energy-efficient solutions with guaranteed high performance.

Continuous improvement is our modus operandi, the method that allows us to create a standard without being constrained by it and then gradually succeeding in surpassing it to define an even higher-level standard.

Research, innovation and technology are the keys to our success: for almost fifty years, the customer's needs have been at the centre of the elements we develop to ensure functional and aesthetic differentiation, all with a sustainable approach.

Our Group's strength lies in the integration between the different areas; our overall vision, experience and transversal competencies mean we can exceed the boundaries of individual products and represent a single partner that can identify integrated application solutions.

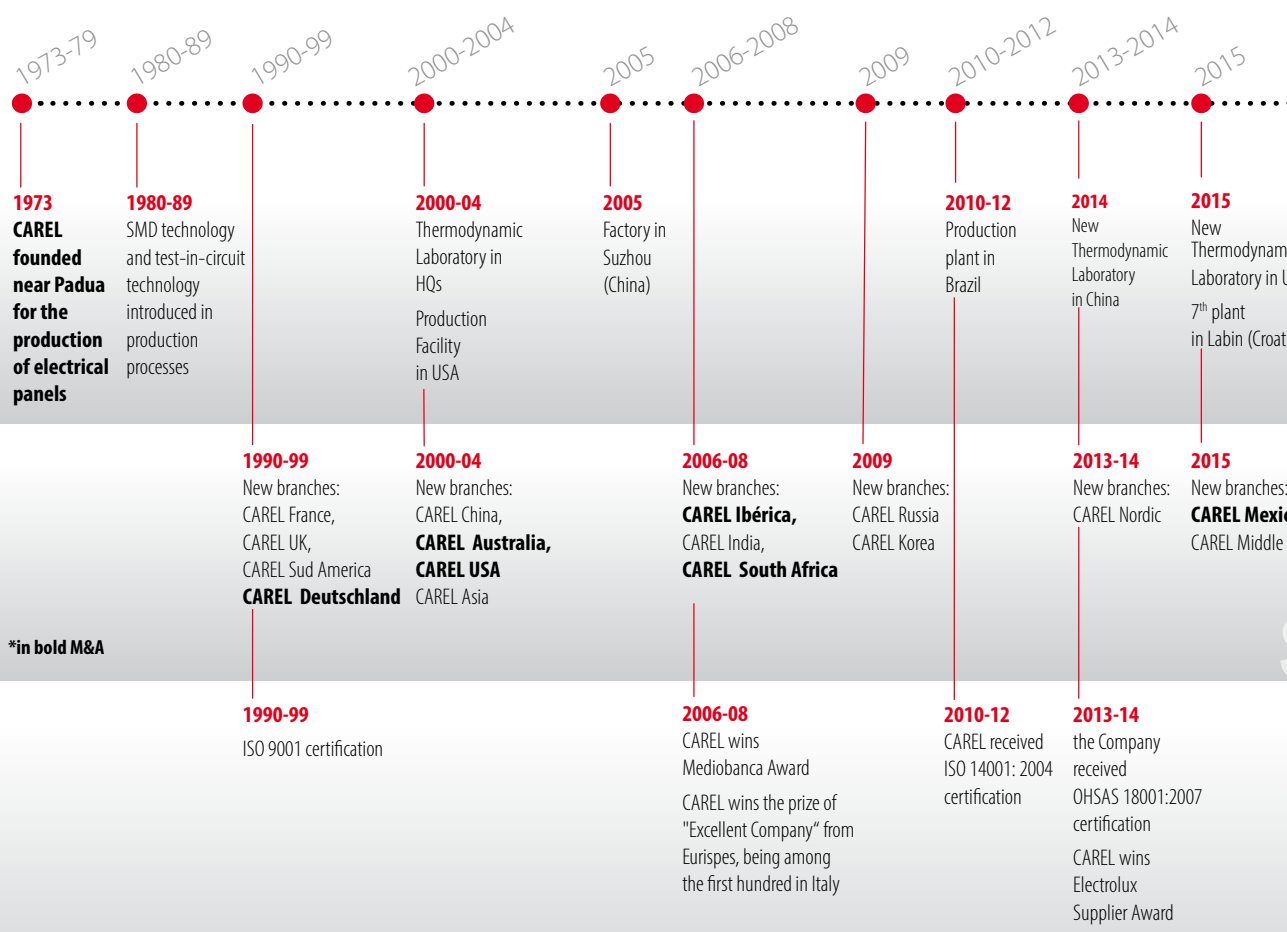

AWARDS

Innovation as a business model

Research & Development are at the heart of our commitment. Every year, almost 6% of consolidated revenues is allocated to Research & Development, so as to anticipate customer needs and provide cutting-edge solutions.

Reliability

Disaster recovery system that sees most of our products manufactured in at least two different sites. This means we can guarantee the supply of our components even in extreme cases.

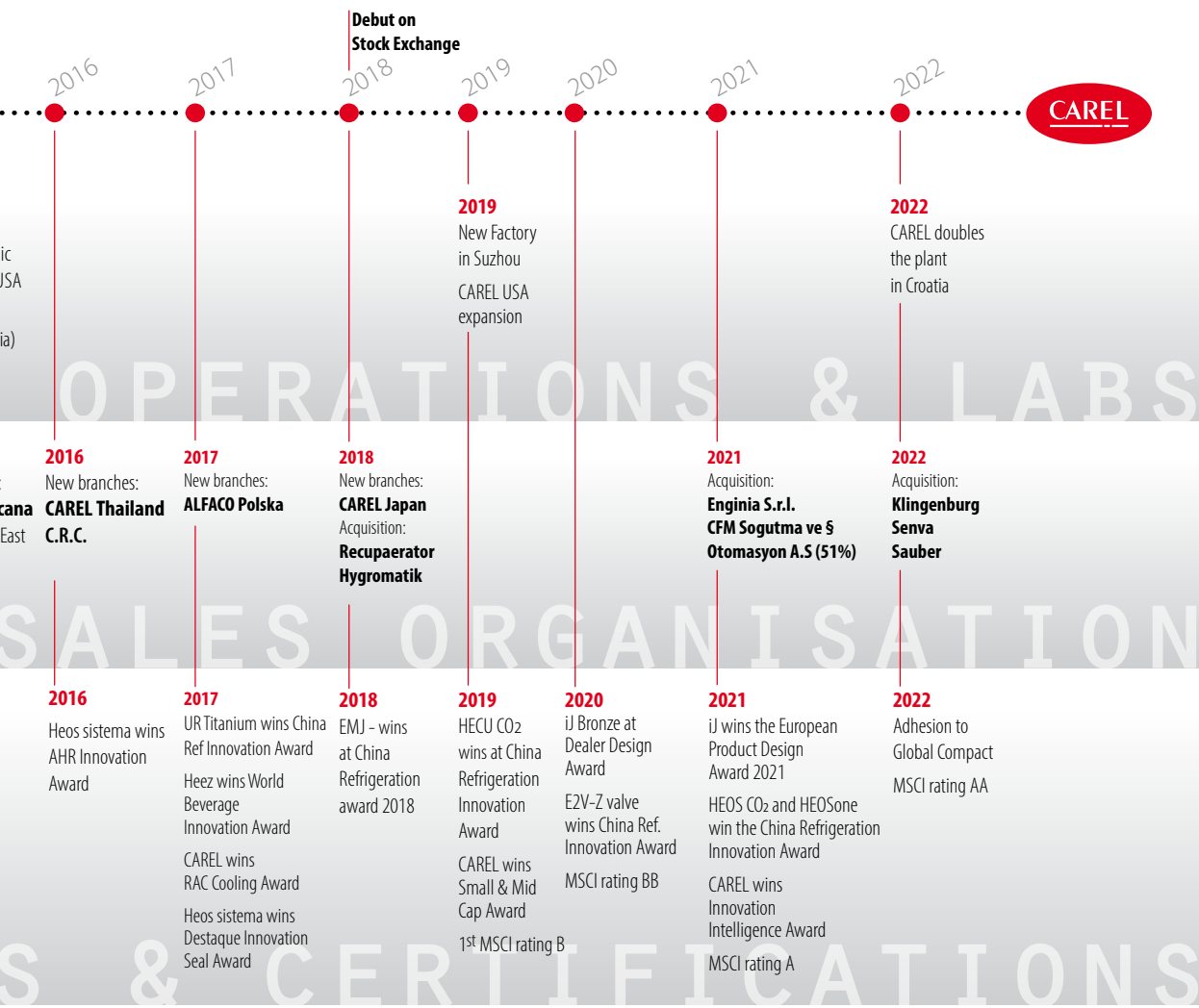

One partner for better air handling units

Through its acquisitions of companies with expertise in this sector, the CAREL Group is now the main one-stop partner for manufacturers wanting to build better air handling units. Our wide range of high-tech integrated solutions is designed to meet the highest requirements in terms of air quality, indoor comfort and energy savings. With Carel on your side, your air handling unit will always be the state-of-the-art.



members of CAREL group



The complete solution

CAREL, leaders in control and humidification systems for HVAC/R applications for more than 40 years, provides advanced solutions for air handling units of any complexity: controllers, humidifiers, heat recovery systems, supervisory tools and a vast range of accessories to make your air handling unit safer and more energy efficient.

Whether you are an OEMs, designer or system integrator, CAREL can offer you a range of integrated solutions that respond to the latest regulatory requirements and recent market trends, so as to develop air handling units with increasingly high-performance in terms of.



HYGIENE
INDOOR AIR
QUALITY



ENERGY
EFFICIENCY



CONNECTIVITY



Terminals



Probes and sensors



Humidifiers



Heat recovery units



Dampers and accessories



Digital services



Electrical panels



DX technology

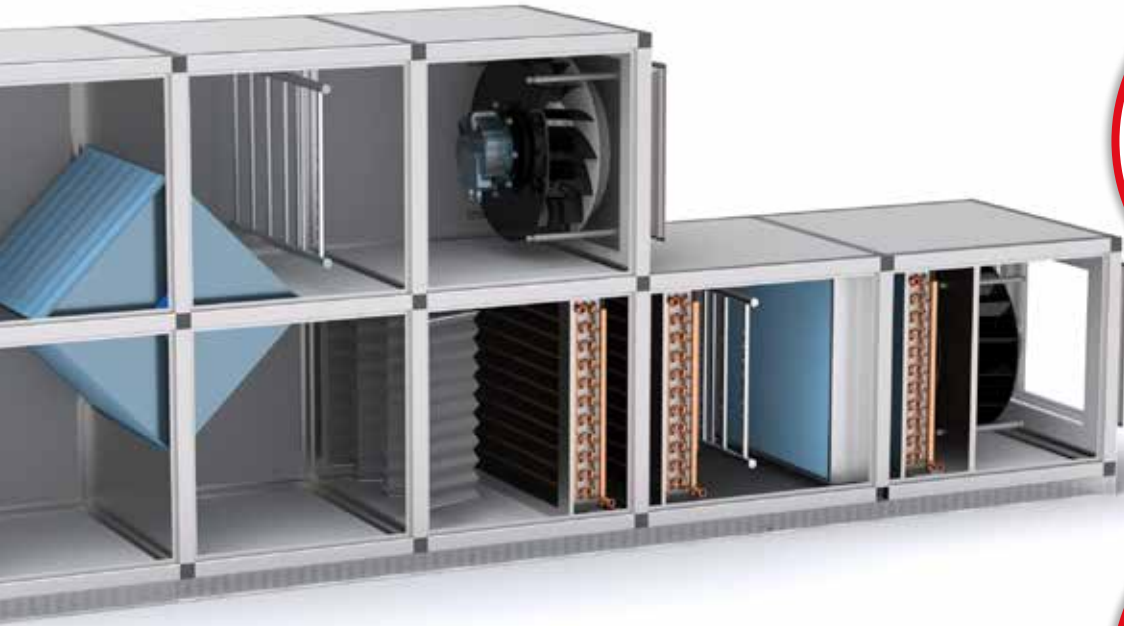

Content

Programmable controllers	11
c.pCO sistema.....	13
c.suite	21
Parametric controllers	23
Parametric controllers.....	25
Unit and room terminals	33
Unit and room terminals	35
Sensors and protective devices	47
Sensors and protective devices.....	49
Humidifiers	59
Isothermal humidifiers	61
Adiabatic humidifiers	81
Heat recovery units	93
Plate heat exchangers.....	95
Rotary heat exchangers	99
Dampers and accessories	105
Dampers and accessories.....	107
DX technology	111
EEV technology	113
Outside condensing unit control	117
Inverters.....	119
Electrical panels	123
Electrical panels for air handling units	125
Remote management systems and digital services	127
Remote management systems and digital services.....	129



Programmable controllers

Air handling units feature an extreme wide variety of components and operating logic. CAREL can offer control solutions that ensure exceptional flexibility, specifically designed according to the customer's requirements. c.pCO sistema is CAREL's latest generation of freely-programmable controllers. A scalable, modular and technologically-advanced solution, the result of continuous optimisation over decades of experience in HVAC applications. The c.suite development tool moreover guarantees maximum programming flexibility, allowing the design and development of applications to make every system your system.



c.pCO sistema

c.pCO sistema is the solution that CAREL offers its partners for managing HVAC/R applications and systems.

c.pCO sistema includes programmable controllers, user interfaces, communication interfaces, remote management systems and cloud services, providing offer OEMs operating in the HVAC sector a powerful yet flexible control system that can easily interface with the most common building management systems (BMS).

c.pCO sistema guarantees highly reliable control of air conditioning and refrigeration units, while at the same time allowing maximum adaptability for differentiation both in terms of appearance and functions.

Several models are available based on the number and type of inputs/outputs, with or without built-in terminal.

The plastic enclosure with DIN rail mounting guarantees high mechanical protection of the board and reduces the risk of electrostatic discharges, while also housing an optional built-in user interface with semi-graphic LCD and 6 LED backlit buttons.

Benefits

- 5 different sizes with from 16 to 55 I/Os;
- Universal channels for I/O flexibility;
- BMS and Fieldbus serial cards and built-in USB interfaces;
- Up to 2 built-in Ethernet ports with web server, FTP connection and tERA cloud access;
- Modbus, BACnet, Konnex, LonWorks, HTTP, FTP, SNMP and OPC UA protocols;
- Built-in electronic valve driver and Ultracap module.



c.pCO

P+5**SE*

The c.pCO family of programmable controllers is the latest evolution of CAREL control technology, featuring unprecedented communication capabilities. With a multitasking operating system and the adoption of standard protocols, local and remote connectivity are the key innovations in the new c.pCO sistema.

The c.pCO controller features specific new functions to improve the efficiency of HVAC/R systems:

- Connectivity - the c.pCO family controllers are the evolution of the pCO5+, with unprecedented connectivity. They offer even the most demanding designers up to 2 built-in Ethernet interfaces, 5 serial lines, 3 of which built-in and configurable in terms of protocol (CAREL or Modbus) and type (FieldBus or BMS), and 2 optional ports, configurable in terms of protocol (Modbus, BACnet, CAREL, CANbus, Konnex, LonWorks) and physical layer (RS485, Ethernet, CAN, Konnex, FTT-10). Standard USB "Host" and "Device" ports are available for programming the c.pCO using a standard USB pen drive, or via a direct connection to a PC without needing an additional external serial converter;
- Operating system - the multitasking operating system ensures optimum use of system resources, extends the data types that can be used to develop the application (32-bit floating point numbers), increases the

application program execution speed and allows independent management of communication protocols.

- I/O flexibility - the CAREL-proprietary ASIC chip used means all c.pCO controllers feature universal I/O channels that can be configured via software as analogue inputs, digital inputs and analogue outputs.

- High efficiency: built-in EVDEVO drivers for controlling electronic expansion valves with Ultracap technology ensure that the stepper electronic expansion valve closes in the event of power failures;

Dimensions

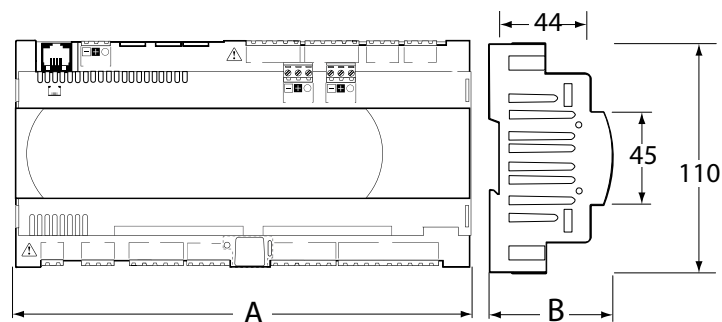

	Small	Medium	Built-in driver	Large	Extralarge
A	227,5	315	315	315	315
B	60	60	60	60	60
B - con porta USB/ terminale integrato	70	70	70	70	70
B - con modulo ULTRACAP	-	-	75	-	-



c.pCO mini

P+D* e P+P*

c.pCOMini is a compact programmable controller in just 4 DIN modules, with high connectivity capabilities and integrated features. It is available in a range that includes models for DIN rail mounting (with or without LCD), and panel mounting. Both models are available in 3 versions (Basic, Enhanced and High-

End), which differ in terms of connectivity and number of I/Os. The main benefits are:

- Built-in high-efficiency ExV, energy saving algorithms and smart device guide;
- Intuitive semi-graphic LCD with icons, languages (Cyrillic, Chinese, etc.), customisable user interface and easy wiring;
- System interoperability with third-

party devices via standard protocols (Modbus®, CAN, BACnet™);

- Cost savings through universal channels for I/O optimisation and fast programmability during production and maintenance.

Versions:

- P+D*: DIN version
- P+P*: PANEL version
- P+D*****E**: display
- P+D*****L**: LED display

c.pCOe

P+E*

c.pCOe is the new I/O expansion card, built using a CAREL-proprietary microchip, that allows considerable flexibility in the configuration of the various pins, both as inputs (support for passive NTC, PTC, PT1000 probes, digital inputs and active voltage and current probes) and as outputs (0-10 V, PWM).

The c.pCOe card is available in 2 versions:

- bBasic version, with a total of 16 I/O channels available, 10 of which can be configured as analogue inputs or outputs, and 6 relays.
- eEnhanced version, same I/O configuration as the basic version, with the addition of a built-in driver for managing a CAREL unipolar electronic expansion valve.

Dimensions

c.pCO mini/cpCOe

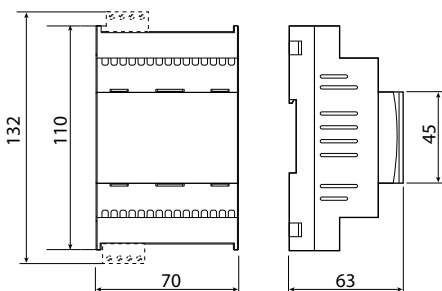

c.pCO mini, panel mounting

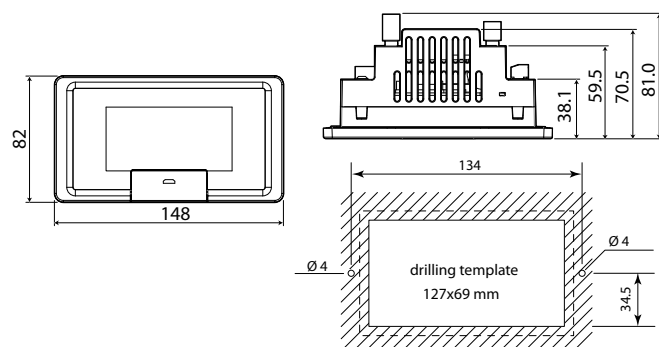

Overview c.pCO

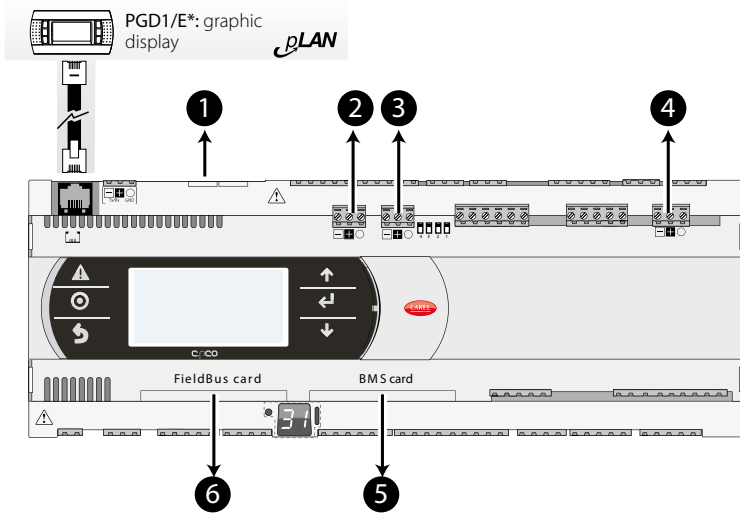

Probes

- SPKT*: 4-20 mA pressure probes - 0-5 V ratiometric probes
- SPKD*: differential pressure transducer
- NTC/PT100/PT500/PTC/PT1000: temperature probes
- DPP*: temperature and humidity probe for industrial environments
- DCPD*
- DCTF*
- DCFL*
- DPW*: temperature and humidity probe for civil environments
- DPD*: temperature and humidity probe for ducts
- protective devices

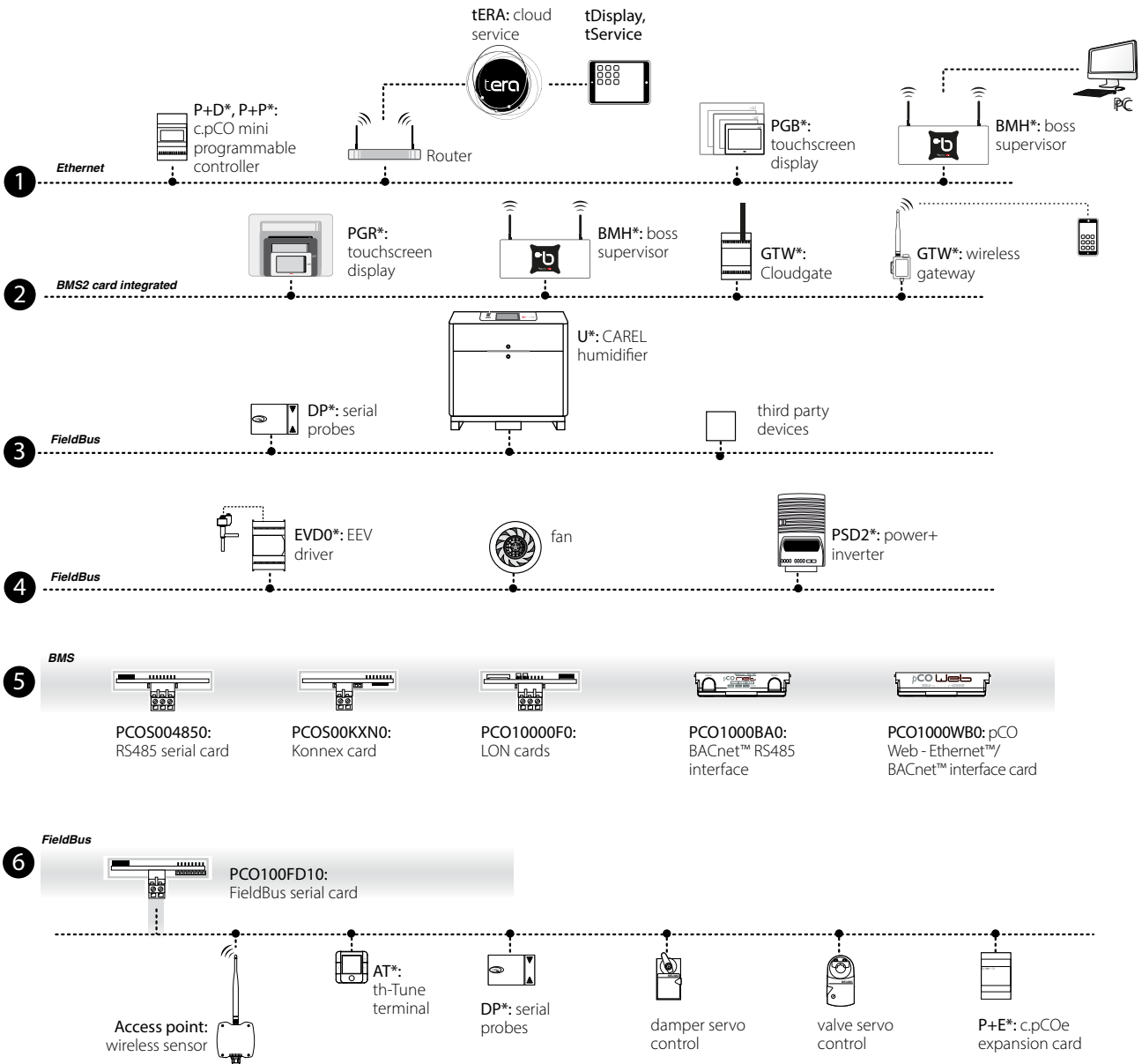

Overview c.pCO mini

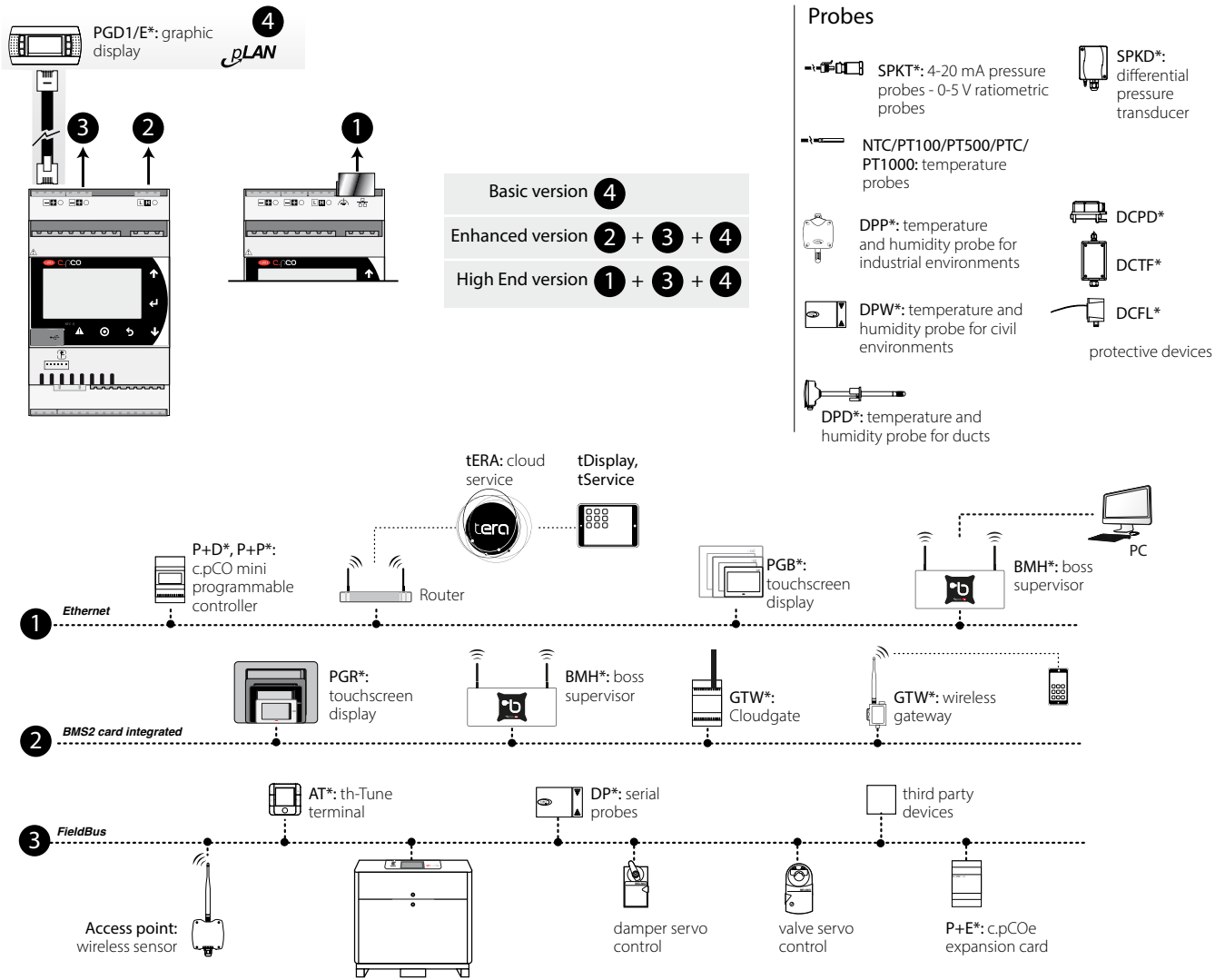

c.pCO sistema technical specifications table

Specifications	c.pCO	c.pCO mini	c.pCOe
General			
Power supply	24 Vac, +10/-15%, 50/60 Hz, 28-36 Vdc, -20/10 Hz	24 Vac +10/-15% 50/60 Hz, 28-36 Vdc +10/-15%;	<ul style="list-style-type: none"> 24 Vac +10/-15% 50/60 Hz, 28-36 Vdc +10/-15% +18 Vdc only for power supply from Ultracap module (EVD0000UC0).
Operating conditions	<ul style="list-style-type: none"> -40T70 °C, 90% rH non-condensing* (version without terminal) 20T60 °C, 90% rH non-condensing* (version with terminal) (*) with Ultracap module fitted: -40T60°C	<ul style="list-style-type: none"> -40T70 °C, 90% rH non-condensing (version without terminal) 20T60 °C, 90% rH non-condensing (version with terminal) 	-40T70 °C, 90% rH non-cond.
Storage conditions	-40T70 °C, 90% rH non-condensing (version without terminal) 30T70 °C, 90% rH non-condensing (version with terminal)	-40T70 °C, 90% rH non-condensing (version without terminal) 30T70 °C, 90% rH non-condensing (version with terminal)	-40T70 °C, 90% rH non-cond.
Ingress protection	Mod. with USB port and/or with Ultracap module: IP20 front panel only	<ul style="list-style-type: none"> IP40 (DIN version) IP65 (panel version) 	IP40 front, IP10 other parts.
Certification	CE/UL		
Assembly	DIN rail		

Input/output table

		c.pCO mini				Small		
		Smart	Basic	Enhanced	High End			
Inputs and outputs								
Universal inputs/outputs	NTC input	10			5			
	PTC input	10			5			
	PT500 input	10			5			
	PT1000 input	10			5			
	PT100 input	max 5			max 2			
	0-1 Vdc/0-10 Vdc input (controller power)	0			max tot 5		max 5	
	0-1 Vdc/0-10 Vdc input (external power)	10 (Notice 1)					max 5	
	0-20 mA/4-20 input (controller power)	max tot 4		max 2 (Notice 2)		max tot 4		max 4
	0-20 mA/4-20 input (external power)			max 4				max 4
	0-5 V input for ratiometric probe (+ 5Vref)	max 2			max 5			
	Digital inputs with voltage-free contacts	10			5			
	Fast digital inputs	max 2			max 2			
	0-10 Vdc output, not opto-isolated	max 5			5			
	PWM output, not opto-isolated	10			5			
	max tot 10			max tot 5				
Digital inputs	24 Vac/Vdc input, opto-isolated	0			8			
	24 Vac/Vdc or 230 Vac (50/60 Hz) input	0			-			
	Voltage-free contacts	0		2		-		
		max tot 0		max tot 2		max tot 8		
Analogue outputs	0-10 Vdc output, opto-isolated	0			4			
	0-10 Vdc output, not opto-isolated	0		2		0		
	PWM output, opto-isolated	0			2			
	PWM output, not opto-isolated	0		2		0		
	Unipolar stepper motor output	0		1		0		
	Bipolar stepper motor output	0			0			
	max tot 0		max tot 2		max tot 4			
Digital outputs	NO/NC relay output	1			1			
	NO relay output	5			7			
	24 V SSR output	2			1			
	230 V SSR output	2			1			
		max tot 6			max tot 8			
Total	16		20		25			
Power supply								
Terminal power supply:	Telephone connector (LAN port)	0			1			
	Display port J3 Disp	1			1			
	Additional terminal power supply	1			1			
Probe power supply:	Active probes power supply	1			1			
	Ratiometric probes power supply	1			1			
Analogue output power supply	0			1				
Ports								
Built-in Fieldbus ports	1	0	1	1	1			
Accessory Fieldbus ports	0			1				
Built-in BMS ports	0*	0	1	0	1			
Accessory BMS ports	0			1				
USB host port	micro USB			1				
USB device port	micro USB			1				
Ethernet	1	0	0	1	2			
Display	Blind		Blind/LCD built-in		Blind/LCD built-in			

Notice 1: CAREL probes P/N DP**Q and DP****2 can only be used with an external power supply and not powered by c.pCOmini.

Notice 2: except for CAREL probes P/N DP**Q and DP****2.

*: alternative to Ethernet

c.pCO								c.pCOe (expansion card)	
Medium		Large		Extra Large		Built-in driver		Basic - c.pCOe	
8		10		8		8		10	
8		10		8		8		10	
8		10		8		8		10	
8		10		8		8		10	
max 3		max 4		max 3		max 3		max 5	
max tot 8	max 6	max tot 10	max 6	max tot 8	max 6	max tot 8	max 6	0	
	8		10		8		8	10 (Notice 1)	
max tot 7	max 6	max tot 9	max 6	max tot 7	max 6	max tot 7	max 6	max tot 4	max 2 (Notice 2)
	max 7		max 9		max 7		max 7		max 4
max 6		max 6		max 6		max 6		2	
8		10		8		8		10	
max 4		max 6		max 4		max 4		max 2	
8		10		8		8		max 5	
8		10		8		8		10	
max tot 8		max tot 10		max tot 8		max tot 8		max tot 10	
12		14		12		12		0	
2		4		2		2		0	
-		-		-		-		0	
max tot 14		max tot 18		max tot 14		max tot 14		max tot 0	
4		6		4		4		0	
0		0		0		0		0	
2		2		2		2		-	
0		0		0		0		0	
0		0		0		0		0	
0		0		0		1/2		0	
max tot 4		max tot 6		max tot 4		max tot 6		max tot 0	
3		5		3		3		1	
10		13		26		10		5	
2		3/4		2		2		2	
2		3/4		2		2		2	
max tot 13		max tot 18		max tot 29		max tot 13		max tot 6	
39		52		55		41		16	
1		1		1		1		0	
1		1		1		1		0	
1		1		1		1		0	
1		1		1		1		1	
1				1		1		1	
1		1		1		1		0	
1		2		2		1		0	
1		1		1		1		0	
1		1		1		1		1	
1		1		1		1		0	
1		1		1		1		0	
1		1		1		1		0	
2		2		2		2		0	

Accessories and options

Serial port expansion cards (from c.pCO Small to Extralarge)



BMS RS485 serial card
PCOS004850

This is used to interface directly with an RS485 network, with a maximum baud rate of 19200. The card guarantees opto-isolation of the controller from the RS485 serial network. (Technical leaflet +050003237)



RS485 serial card
PCO100FD10

This is used to connect via an electrically isolated interface to an RS485 network. The function implemented is MAIN (i.e. supervisor), and therefore other SECONDARY controllers or devices can be connected. A maximum of 64 devices can be connected. (Technical leaflet +050003270)



Ethernet - pCOweb interface card
PCO10W0WB0

This is used to connect the controller to a 10 Mbps Ethernet network so as to carry out the following functions:

- access information on the controller (network variables and parameters) from an Internet browser such as Internet Explorer™ installed on a PC and connected via TCP/IP to pCOWeb;
- connection to a supervisory network that uses the protocols specified in the technical leaflet.

(Technical leaflet +050003238)



BACnet MS/TP - pCOnet interface card
PCO10W0BA0

This is used to connect the controller to a BACnet MS/TP network (MAIN/SECONDARY Token pass) The RS485 connection is optically-isolated from the controller. (Technical leaflet +050000930)



Konnex interface card
PCOS00KXN0

This is used to connect to a network operating according to the Konnex® standard. BMS port and FieldBus port models are available.

(Technical leaflet +050000770)

Konnex interface card
PCOS00KXF0

See the description of the PCOS00KXN0 serial card (previous paragraph).

(Technical leaflet +050000770)

External modules



Ultracap module for c.pCO built-in driver
PCOS00UC20

This module guarantees temporary power supply to the valve driver only in the event of a power failure, for sufficient time to immediately close the connected electronic valve or valves (1 or 2). (Technical leaflet +0500041E)



External Ultracap module
EVD0000UC0

DIN rail mounted, this can be connected as an alternative to the PCOS00UC20 Ultracap module. It can also be used in applications with electronic expansion valve drivers that are not built into the controller (see technical leaflet +05000581E). (Technical leaflet +05000421E)

Wireless gateways



RS485/TTL Bluetooth and RS485/TTL to WiFi serial gateway
GTW0000BTO; GTW0000WTO

These new gateways provide BLE and WiFi wireless connectivity on the c.pCO platform. They convert the controller's RS485 serial communication into Bluetooth or WiFi transmission, depending on the model. In this way, the CAREL family of programmable controllers is also enabled for the new user experience introduced by apps for commissioning, service and remote control.



c.suite

c.suite is the programming suite for the c.pCO family programmable controllers, designed as a set of interdependent modules for each stage of application development for HVAC/R units or systems.

c.suite allows a team of professionals with different skills to work as a team on the same project, increasing the efficiency of each team member. The application program is developed as logically-independent parts by different professionals, each of whom uses a different software tool. All of these SW tools cooperate with each other by continuously exchanging data, and as an option can be managed by a software versioning control system (SVN).

To each their own tool: with c.strategy, the expert in thermodynamic algorithms can prepare the heart of the system's operating logic; with c.mask, the developer can create the most suitable user interface: when the application program is ready, in c.design it can be transferred to any hardware configuration by configuring the controller type and size, I/O mapping, communication protocols, default parameters, data loggers, etc. For OEMs, then, c.factory can be used to program the controllers on the production line,

load the application program onto the controller as configured, while in the field the commissioner can use c.field to help set-up the system, with full access to parameters, alarms and real-time monitoring with graphs.

c.suite provides a wide range of libraries with different functions: from basic logic-arithmetic functions, to complex control algorithms for managing various devices, both CAREL and third-party. Combining these elements with the AHU manufacturer's know-how allows the application to be designed and developed so as to make every system your system.

Benefits

- Team work;
- Programming libraries;
- Debug-on-target;
- Totally-independent logic and HW;
- Commissioning tool.

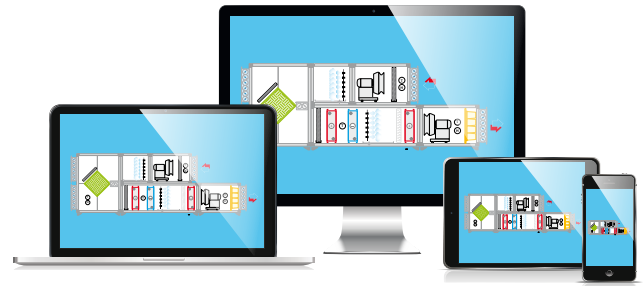

c.strategy

This is the tool used to develop the logic and create the temperature control algorithms. It allows complete independence of the control logic from the hardware and devices connected to the network. It supports IEC 61131 standard languages (ST, FBD, SFC, Ladder) and 32-bit data types, including REAL (floating point) numbers. It features the “Debug on target” function, i.e. the possibility to verify the algorithm in real time while it is running on the controller (via USB or Ethernet port).

c.design

This is used to configure the type and size of the control board, the I/O configuration, the communication protocols, the default parameters and the data recorded periodically or on-event. For each c.strategy/c.mask project, multiple configurations can be saved in c.design and then selected when loading the application software onto the programmable control.

c.factory

A completely new tool, designed for the OEM production line. This can be used for programming the controllers during production, so as to set up the application software and select the most appropriate configuration during assembly. It is designed to allow integration with the most commonly-used production line process software. It is command-line programmed and can manage a barcode reader.

c.suite workflow



c.strategy



c.design



c.factory

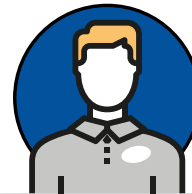

c.field

c.mask

This is the environment used specifically for creating the graphic human-machine interface. c.mask can be connected to the logic developed in c.strategy, so that any modifications made by the thermodynamic designers are available in real time to the interface designer.

c.web

c.web is an extremely useful tool for creating HTML5 websites to upload onto the c.pCO controllers. No specific knowledge of web technologies is needed, being based on simple graphic objects, similar to 1Tool Touch Editor.

c.field

c.field is the tool designed for personnel who work directly in the field. The interface allows real-time interaction with the controller so as to set parameters, check alarms, create new configurations, view live trends and log data for analysis and fine tuning.



Parametric controllers

CAREL's parametric controls are the result of decades of experience in HVAC systems.

These controllers cover the widest possible range of typical unit configurations, providing smart logic to ensure comfort, indoor air quality and, at the same time, the highest energy efficiency. Designed to be easy to use, these are the perfect response to the need to save time and costs, from design to commissioning.



Parametric controllers

CAREL's parametric controls are the result of decades of experience in the design of control solutions for HVAC systems.

Parametric controllers provide users all the power of CAREL technology for the control of air handling units in a ready-to-use solution, without requiring any programming language skills.

These solutions feature extremely flexible hardware and software. A wide range of applications can be customised by simply setting specific parameters. Indeed the same product can manage numerous different application schemes, from simple heat recovery units to modular and complex air handling units, quickly and easily. These reliable solutions incorporate architectures that have been tested and validated over many years of experience, with support documentation for quick implementation in the field.

The control logic is the result of CAREL's vast experience in the sector, with a vast number of readily-available intelligent control functions available to ensure indoor comfort and air quality with the highest energy efficiency.

CAREL parametric solutions fully exploit the potential of connectivity and user interfaces, offering users a quick and easy way to have everything under control at all times.

Benefits

- Flexibility
- Modularity
- Ease of use,
- Advanced user interfaces



UAR*

μAria is Carel’s solution for the complete management of ventilation and heat recovery units in residential environments. The objective of this product is to extend and complete the CAREL proposal for the OEM residential ventilation market, through a solution for medium-low end units.

The new hardware is more compact and has more I/Os, combining costs, features, compactness and flexibility, all key factors for this type of application. The application software includes more than 20 configurations for different types of units, covering various different types of heat exchangers, heat recovery, electric and water coils equipped on the units available on the market.

Compatibility with different types of probes and sensors (temperature, humidity, CO2, VOC, etc.) guarantees the possibility to measure the desired values and use them for optimised control.

Ready To Use

Ready-to-install product, complete with pre-loaded configurations that can be easily loaded using the app. Install, start, download the app and start using the controller.

Flexibility

Supports different types of devices for residential units, with compact dimensions and powered directly by the controller, without transformers: save time and space.

Connectivity

Simplified integration of field components, such as room terminals, probes and expansions on the RS485 Fieldbus line, as well as compatibility with higher-level supervisory systems or BMS via RS485 serial communication. The display also features local NFC and Bluetooth connectivity for direct connection to the app.

Dimensions

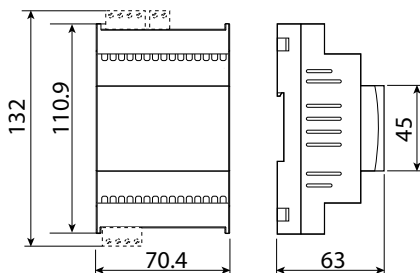

Typical heat recovery unit diagram

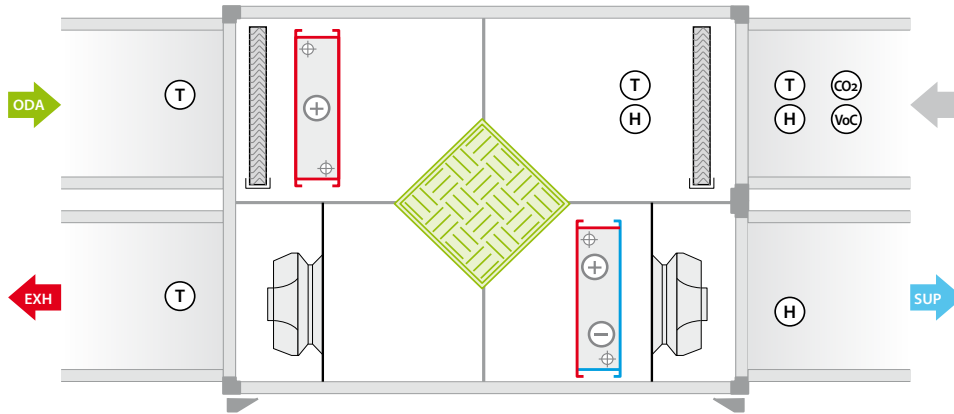

Main functions

Comfort

- Temperature control based on five different set points;
- Room humidity control with increased outside air flow-rate.

Indoor air quality

- Air quality control based on CO₂ and VoC set points

Auxiliary functions

Freecooling/freeheating;
Cleaning;
Night ventilation;
Post-purge.

Usability

μAria is designed to support the APPLICA app for remote control, service, commissioning and parameter setting. Using the NFC or Bluetooth connectivity available in the HMI, APPLICA can directly access the controller and provide a simple and intuitive graphic interface. APPLICA is available for Android and iOS smartphones.



Overview μ Aria

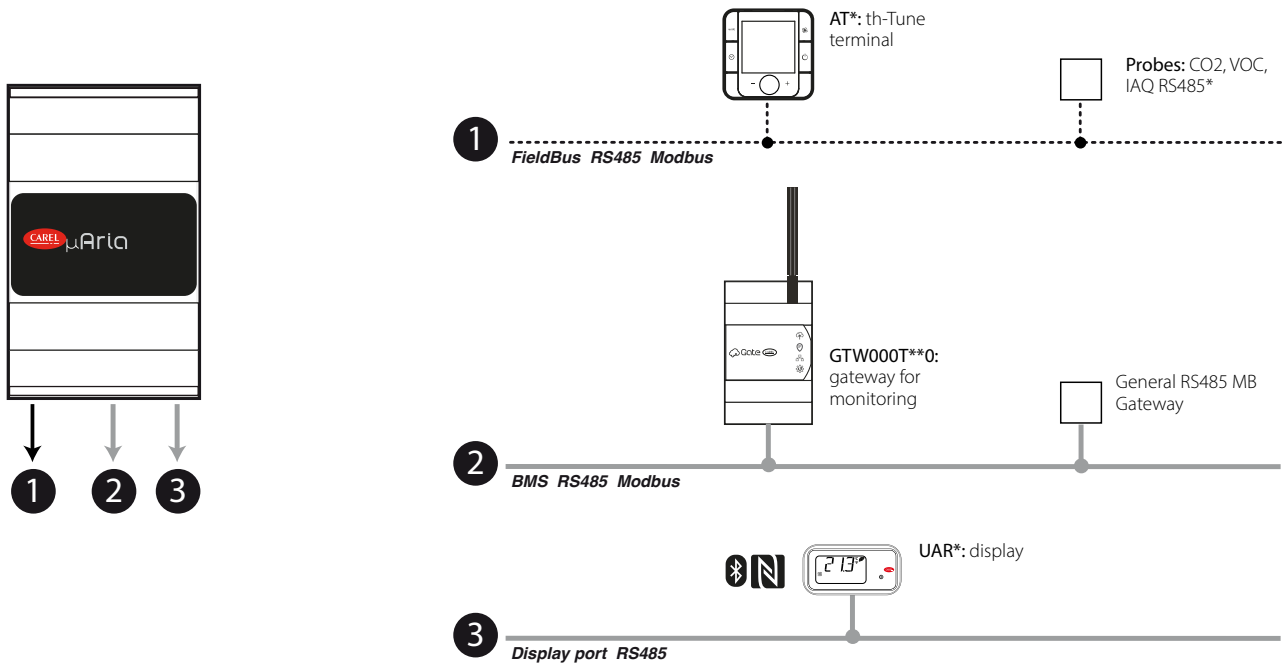

Technical specifications

Specifications	μ Aria basic	μ Aria Enhanced
	UARAD00001370	UARADE0001320
General		
Power supply	115-230Vac, 50/60Hz	
Operating conditions	-20T60°C, <90% rH	
Storage conditions	-40T85°C, <90% rH	
Modules	4 DIN	
Mounting	DIN rail	
Terminal block	Plug-in male-female.	
Certification	CE/UL	
Inputs and outputs		
Digital outputs	4	5
Digital inputs	4	4
Analogue outputs	4	6
Analogue inputs	6	6
Connectivity		
Built-in BMS RS485	1	1
Built-in FieldBus RS485	1	1
Display port	1	1
NFC-BLE connectivity	Si (con display accessorio AX55030PS20A0)	
Communication protocols	Modbus® RTU	



k.air

P+DA0*, P+5A0*

k.air is the controller designed for the management of air-conditioning and ventilation units. It is a ready-to-use solution that allows users to benefit from CAREL's expertise without requiring any programming skills, saving time and costs from design to commissioning. Thanks to its modular and flexible concept, k.Air can adapt to different types of units, from small ventilation units up to medium/large air handling units.

The distinctive feature of k.Air is the result of CAREL's extensive experience in air handling unit and humidification management applications. Its intelligent control logic in fact ensures comfort, indoor air quality and a healthy environment, always with the lowest energy consumption.

k.Air offers an advanced user experience: simplified access to information for users and service via an built-in web interface. A set of graphic pages with unit dashboards are available from first start-up, ready to be used with the new pGDx family of touchscreen displays.

Flexibility

A single product with modular architecture, designed to adapt to a wide range of unit layouts.

Plug&play

Easy configuration and commissioning using pre-loaded layouts and custom configurations generated by an external tool or directly on the unit's display.

Connectivity

Simplified integration, both in the field with the unit's components and with higher-level supervisory systems or BMS via built-in serial and Ethernet communication, plus native availability of standard building automation protocols such as Modbus and BACnet.



Available on CPQ!

CAREL CPQ is the product selection and configuration tool designed to make the work of designers, customers and partners faster and simpler.

Dimensions

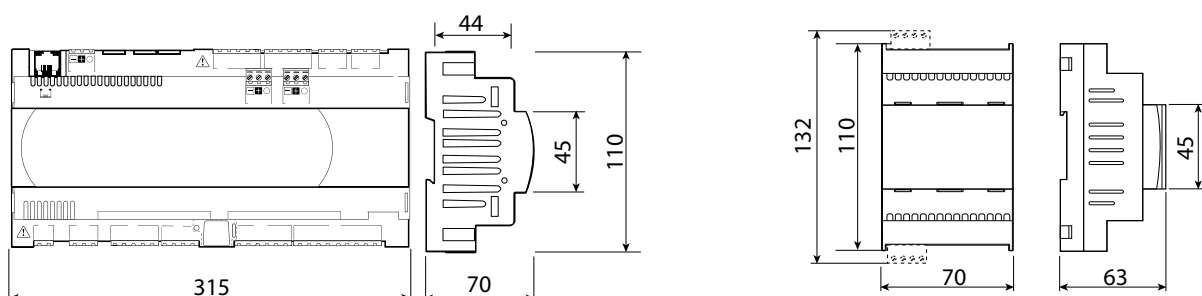

Typical air handling unit layout

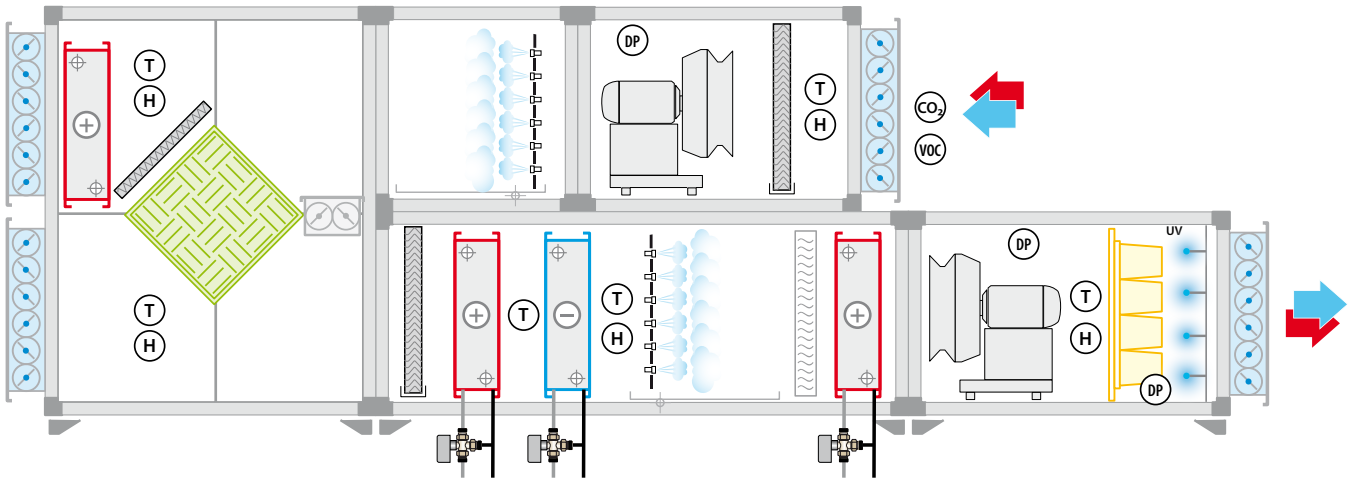

Main functions

Comfort

- Temperature control based on five different set points
- Humidity control with relative or absolute humidity set point
- Accurate humidification control with modulating limit probe
- Integrated control of CAREL humidifiers
- Up to four auxiliary control loops for managing generic ON/OFF and modulating devices

Indoor air quality

- Controlled ventilation based on CO₂ and VOC sensors
- Fan speed control by pressure, flow-rate and temperature
- Filter pressure drop monitoring
- Air sanitation device management
- VDI-6022 program, with functions to improve unit hygiene based on the requirements of the VDI standard.

Energy saving

- Management of modulating EC fans
- Management of free cooling, free heating and Heat recovery
- Sequential control of heating and cooling devices with up to 6 stages
- Indirect evaporative cooling management
- Integrated management of internal heat pump modules with BLDC compressor, or management of external condensing units via the uChiller controller connected to the main coil
- Continuous monitoring of heat recovery unit and fan performance

Usability

Integrated web interface with graphic pages and dashboard, ready to use from first start-up, for the highest-level user experience.



k.air overview

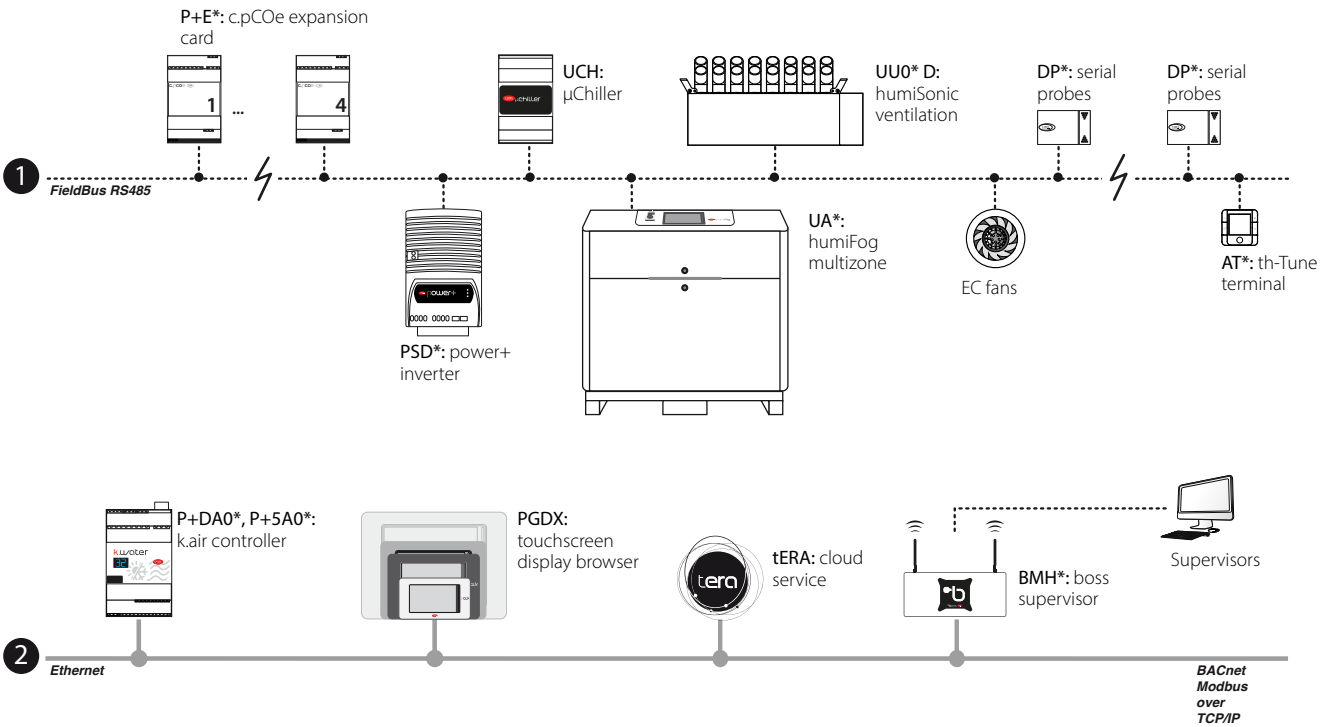
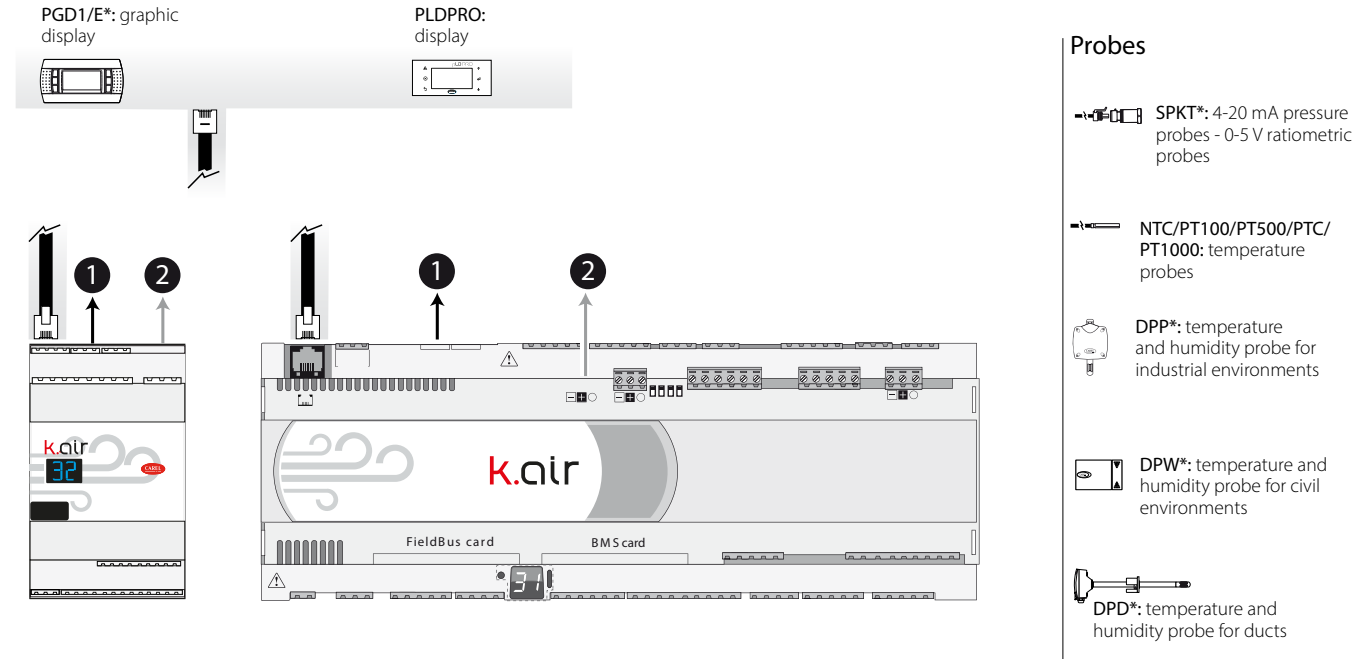

Input/output table

Specifications	Mini	Large
	P+DA00FHD0LFK	P+5A0SFC000LK
General		
Power supply	24 Vac (10/-15 %) 50/60 Hz; 28-36 Vdc (-20/10%)	
Driver probe power supply	+5 Vdc / +12 Vdc	+5 Vdc / +12 Vdc
Operating conditions	-40T70 °C, 90% rH non-condensing (-30T70 °C, 90% rH non-condensing with built-in terminal)	
Storage conditions	-40T70 °C, 90% rH non-condensing (version without terminal) 30T70 °C, 90% rH non-condensing (version with terminal)	
Ingress protection	IP40	IP20
Modules	4 DIN	18 DIN
Assembly	DIN rail	
Terminal block	Connector kit included	Connector kit included
Certification	CE/UL	
Inputs and outputs		
Digital outputs	6	18
Digital inputs	2	18
Analogue outputs	2	6
Universal inputs/outputs	10	10
Built-in ExV driver	yes	no
Connectivity		
Built-in BMS RS485	-	1 (opto)
Built-in FieldBus RS485	1	2 (opto)
Display RS485 port	1	1
Optional BMS RS485 card	No	1
Optional FieldBus RS485	-	1
Ethernet port	1 (10/100 Mbps)	2 (10/100 Mbps)
Built-in Ethernet switch	-	Yes
USB Host	Yes	Yes
USB device	Yes	Yes
Webserver	Yes	Yes
Communication protocols	Modbus® RTU and TCP/IP BACnet™ MS/TP and IP	Modbus® RTU and TCP/IP BACnet™ MS/TP and IP
Accessories		
I/O expansion module P+E0000000000	up to 4, with 10 universal inputs, 6 digital outputs	



Unit and room terminals

Unit and room terminals allow users to operate and interact with the air handling units at all levels, to access information at a glance and understand the unit's operating status. Whether you are an installer, a maintenance technician or an end user, CAREL has a wide range of models that provide the best solution for every requirement in terms of performance, cost and aesthetics.



Unit and room terminals

The structure and modularity of CAREL terminals mean the best solution is always available for different needs in terms of usability, costs and appearance.

The new pGDx range has been designed for high-end applications that require touchscreen technology, combined with an elegant design and extensive connectivity possibilities.

The pGDN series is focused on applications that require a good compromise between performance, competitiveness and appearance.

The pLD series (programmable LED display) is ideal for applications where the main requirements of the user interface are low costs and less space required for installation.

The th-Tune series room terminal has been designed as a simple and intuitive interface solution for installation in rooms.

Benefits

- wide range of formats;
- wide range of solutions for all needs;
- installation on the unit or in the room;
- built-in temperature and humidity probes (pGDx models);
- WiFi and Ethernet connectivity (pGDx models).



pGDx

PGDX*

The pGDx family is CAREL's response to the needs of an increasingly demanding market regarding human-machine interfaces, both in terms of size and performance. The touch screen panel considerably facilitates interaction between the user and the unit by simplifying navigation between the different screens. To ensure maximum flexibility, several different versions are available, in terms of screen size (4.3", 7", 10" and 15"), connectivity (RJ12, one or two Ethernet ports, WiFi) and types of touchscreen (resistive/capacitive).

Starting from pGDx 4.3", which can be used to evolve HVAC/R units designed for the pGD1 without modifying any of the electrical connections, the proposal has been expanded to include the brand pGDx 7"; this takes the concept of unit terminal to a whole new level, extending connectivity via the WiFi connection (both in Access Point and Station mode). The range is completed by 7" and 15" capacitive displays that guarantee an unprecedented user experience.

pGDx is available in two different versions - Runtime and Browser. The Runtime version is programmable using the c.touch suite, and allows quick conversion of projects created with the previous 1 tool Touch Editor. The Browser version can directly display the c.pCO web server interface, developed using c.web editor or other web editors.



Unit terminal

IP66 protection rating, NEMA certification

These features allow pGDx to be installed in outdoor environments with particularly challenging operating conditions.

Two Ethernet ports

Additional connectivity functions and easier use of the contents. Can be used in both dualMAC and switch mode. [valid for 7", 10" and 15" models].

USB port

Front micro-USB port, concealed by the faceplate, for installation and software updates without requiring special tools [valid for 4.3" and 7" resistive versions, full USB for 10" and 15" 7" and 15" capacitive models].

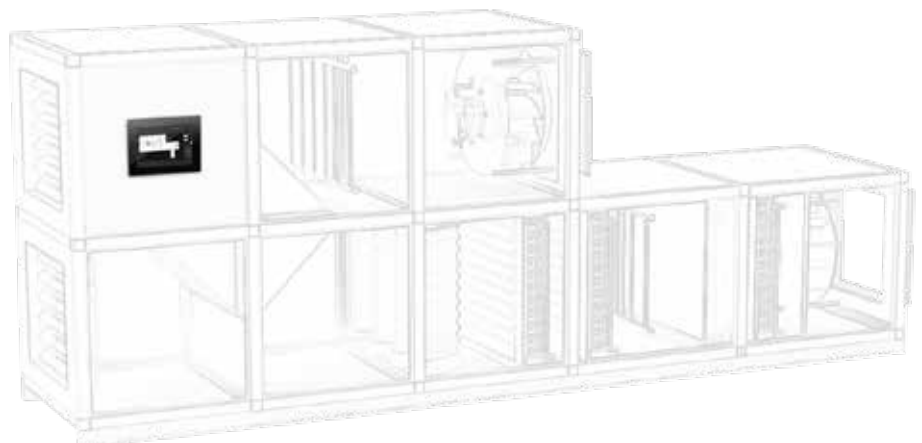



Room terminal

Built-in temperature and humidity probe

This probe can share the values read with both the display and the connected controller.

WiFi

This provides wireless communication to the controller networks and any external devices. The displays can also be used

as a Wireless Access Point (WAP) or as a Wireless Client Station. [valid for 4.3" and 7" models].

Wall-mounting

A complete assortment of accessories for easy installation on the wall, both horizontally and vertically, suitable for more elegant spaces.



Accessories

Frames for 4.3" - 7" resistive

PGTA00FW00	Standard Carel white frame for pGDx 4.3"
PGTA00FW10	Neutral white frame for pGDx 4.3"
PGTA00FB00	Standard Carel black frame for pGDx 4.3"
PGTA00FB10	Neutral black frame for pGDx 4,3"
PGTA00FT00	Standard white transparent frame with T/H probe holes for pGDx 4.3"
PGTA00FT10	Neutral white transparent frame with T/H probe holes for pGDx 4.3"
PGTA00FH00	Standard black transparent frame with T/H probe holes for pGDx 4.3"
PGTA00FH10	Neutral black transparent frame with T/H probe holes for pGDx 4.3"
PGTA00FW20	Standard CAREL white frame for pGDx 7"
PGTA00FB20	Standard CAREL black frame for pGDx 7"
PGTA00FT20	Standard white transparent frame for pGDx 7"
PGTA00FH20	Standard black transparent frame for pGDx 7"
PGTA00RM40	Flush mounting case for pGDx 4.3"
PGTA00RM40	Flush mounting case for pGDx 7"
PGTA00SM40	Surface mounting case for pGDx 4.3"
PGTA00SM40	Surface mounting case for pGDx 7"

Power supplies

PGTA00TRX0



Power supply module for pGDx 4.3" - 7"
110-230 Vac IN - 24 Vdc OUT



PGTA00TRF0

Power supply module for pGDx 7" - 15"
110-230 Vac IN - 24 Vdc OUT

Dimensions

pGDx 4,3" resistive

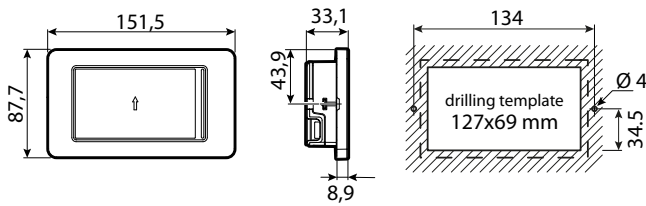

pGDx 7" resistive

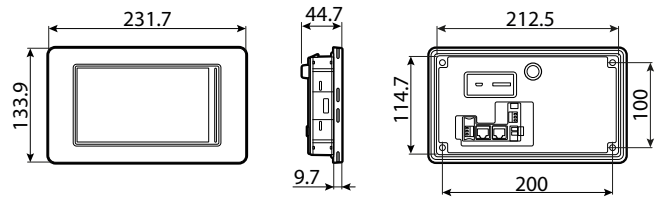

pGDx 7", 10 e 15" capacitive

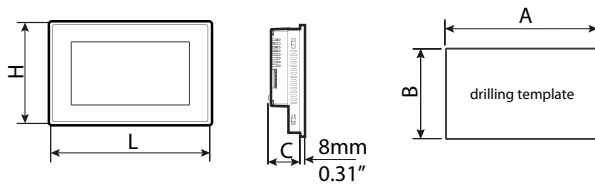

	A	B	C	H	L
pGDx 7" (PGB07010FBCA0)	176mm 6.90"	136 mm 5.35"	47 mm 1.85"	147 mm 5.79"	187mm 7.36"
pGDx 10" (PGB10010FCCA0)	271 mm 10.66"	186 mm 07.32"	56 mm 02.20"	197 mm 07.75"	282mm 11.10"
pGDx 15" (PGB15010FCCA0)	411 mm 16.18"	256 mm 10.00"	56 mm 02.20"	267 mm 10.50"	422mm 16.60"

Overview drawings

pGDx runtime 4,3" resistive

Models with R12 connector

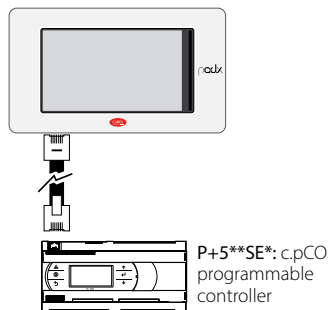

Models with RS485/WiFi screw terminal

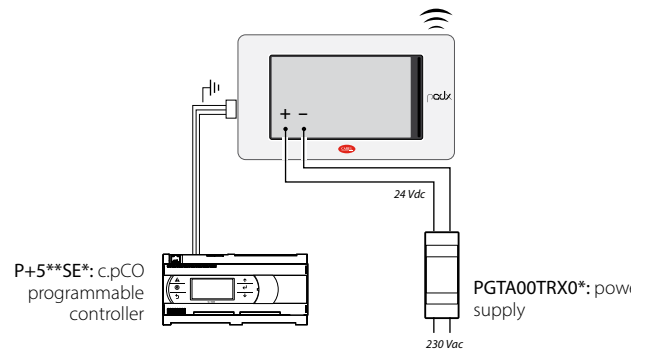

pGDx browser 4,3" resistive

Models with Ethernet/WiFi connector

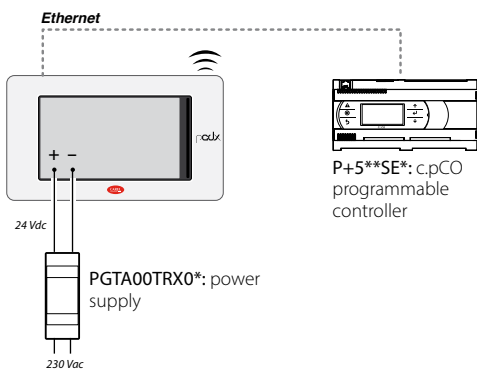

Models with Ethernet connector and RS485/WiFi screw terminal

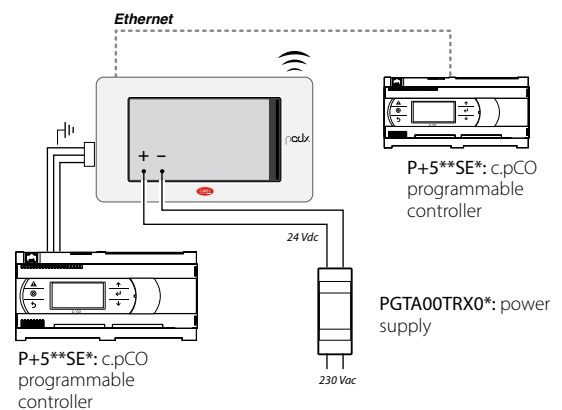

pGDx 7" resistive

Ethernet switch configuration

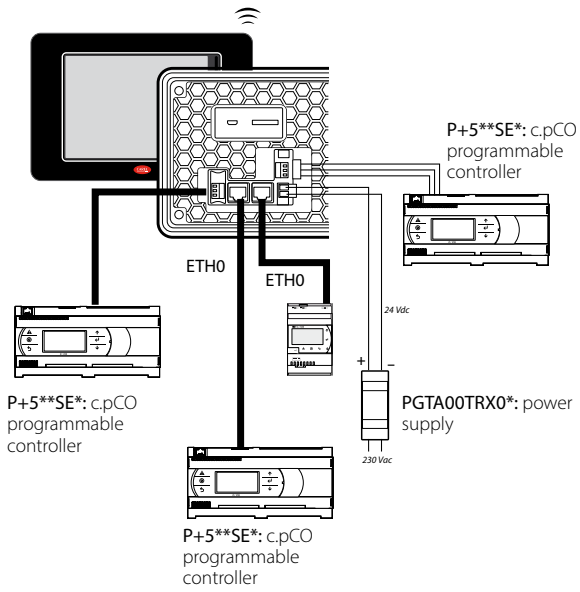

Dual MAC Ethernet configuration

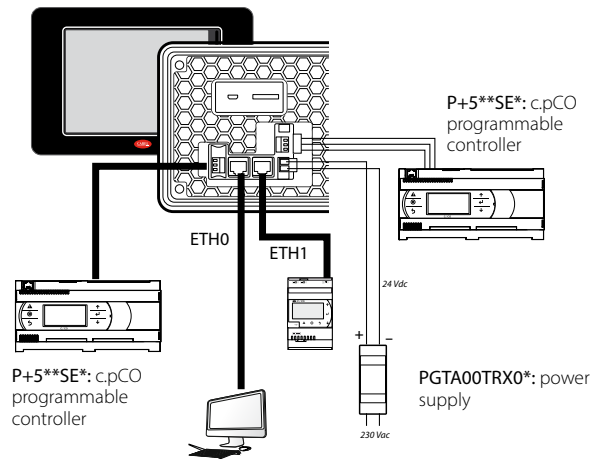

pGDx 7"/15" capacitive

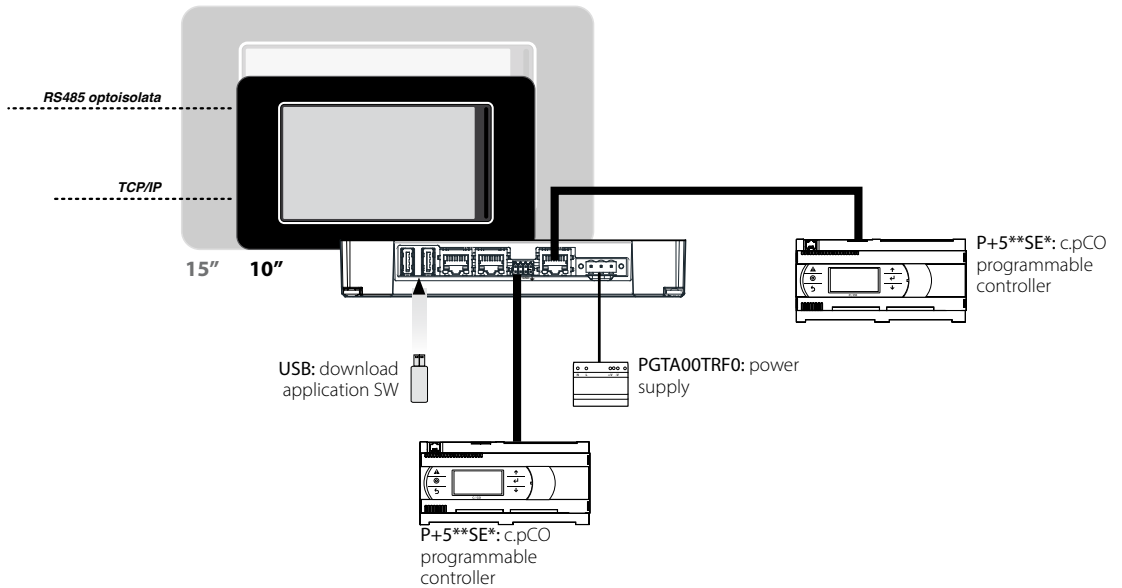

Technical specifications table

Specifications	pGDx 4.3	pGDx 7"	pGDx 10"	pGDx 7"	pGDx 10"	pGDx 10"
Touch type	resistive	resistive	resistive	capacitive	capacitive	capacitive
CAREL part number	PG[R/B]04*	PG[R/B]07*	PGB10010FA0D0	PGB07010FBCA0	PGB10010FCCA0	PGB15010FCCA0
Brightness (cd/m2)	200	500	200	500	500	400
Resolution	480x272	800x480	1024x600	800x480	1280x800	1366x768
Colour bits	16 bits	24 bits	16 bits	24 bits	24 bits	24 bits
LED bar	yes	yes	no	no	no	no
WiFi	optional	optional	no	no	no	no
Ethernet ports available	1	1-2	1	2	2	2
USB ports	1-2	1-2	1	2	2	2
Serial ports	1	1-2	1 (DB9 - PGTA00CNV0)	1 (8 pin)	1 (8 pin)	1 (8 pin)
Number of cores	1	1	1	2	2	4
Runtime/browser	specific part number	specific part number	selected at power on	selected at power on	selected at power on	selected at power on
Buzzer	optional	optional	no	no	no	no
RAM	512 MB	512 MB	512 MB	1 GB	1 GB	2 GB
Flash memory	4 GB	4 GB	4 GB	4 GB	4 GB	8 GB
Modbus over Plan protocol / PLAN option (emulatore pGD)	si	si	no	no	no	no
T/H sensor	Specific part number	Specific part number	no	no	no	no
Power supply	PGTA00TRX0	PGTA00TRX0	PGTA00TRF0	PGTA00TRF0	PGTA00TRF0	PGTA00TRF0
Front panel mounting	Specific part numbers	Specific part numbers	yes	yes	yes	yes
Rear panel mounting	Specific part numbers	Specific part numbers	no	no	no	no
Flush wall mounting	Specific part numbers with PGTA00SM40	Specific part numbers	no	no	no	no
Recessed wall mounting	Specific part numbers with PGTA00SM40	Specific part numbers with PGTA00RM70	no	no	no	no
Operating temperature [°C]	0T50, -20T60 Specific part numbers	0T50, -20T60 Specific part numbers	0T50	-20T60	-20T60	-20T60

Model selection guide

pGDx 4,3" browser

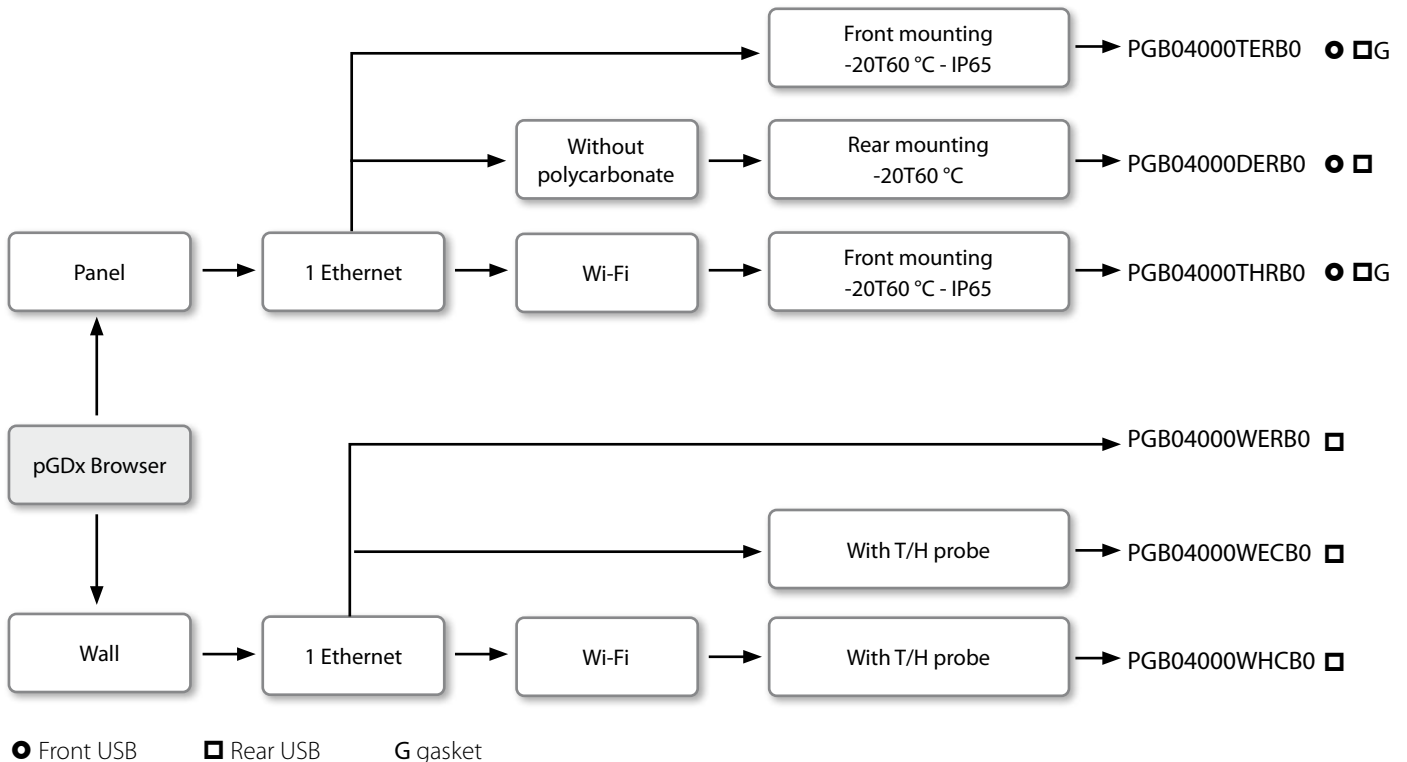

pGDx 4,3" Runtime

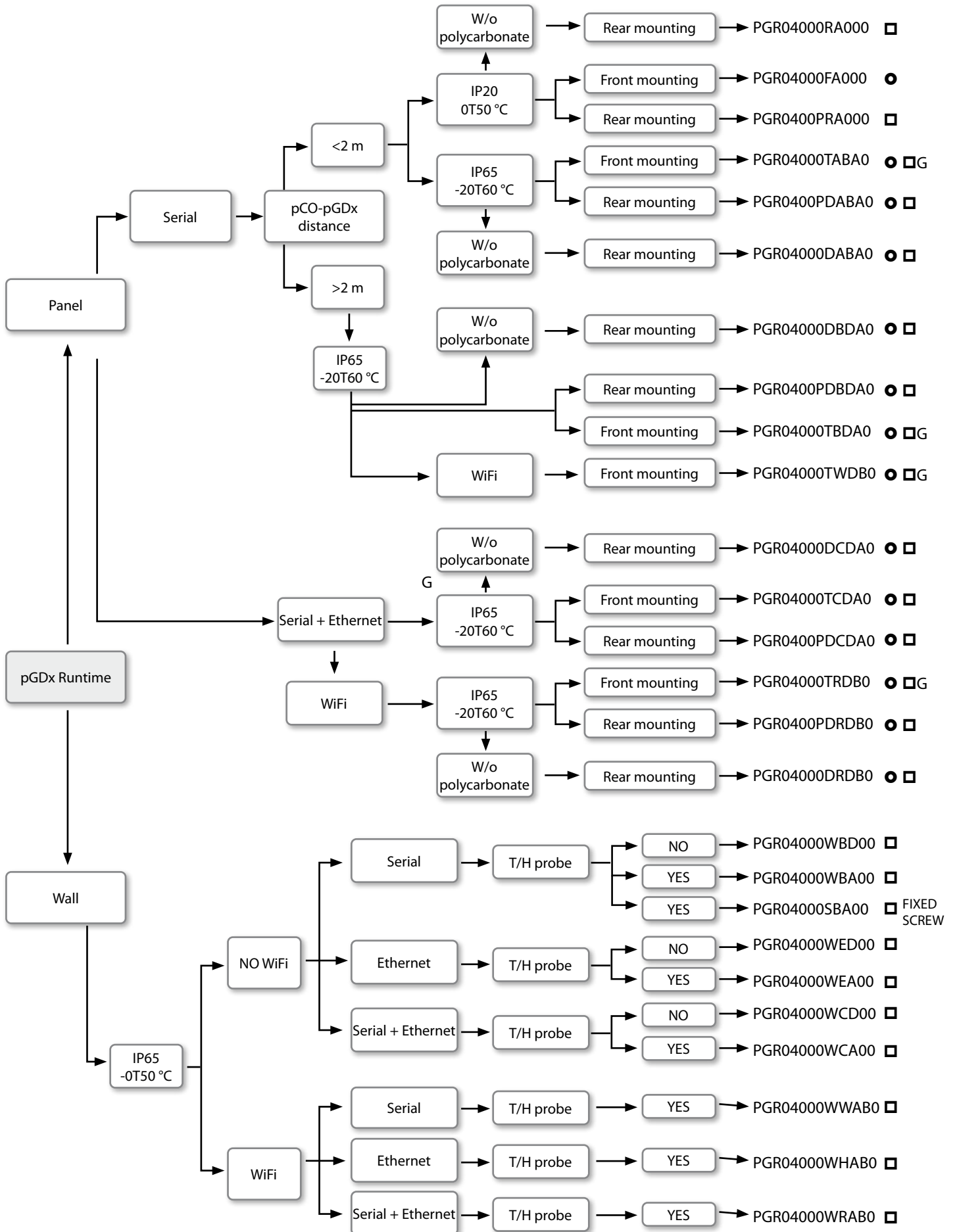

pGDx 7" browser

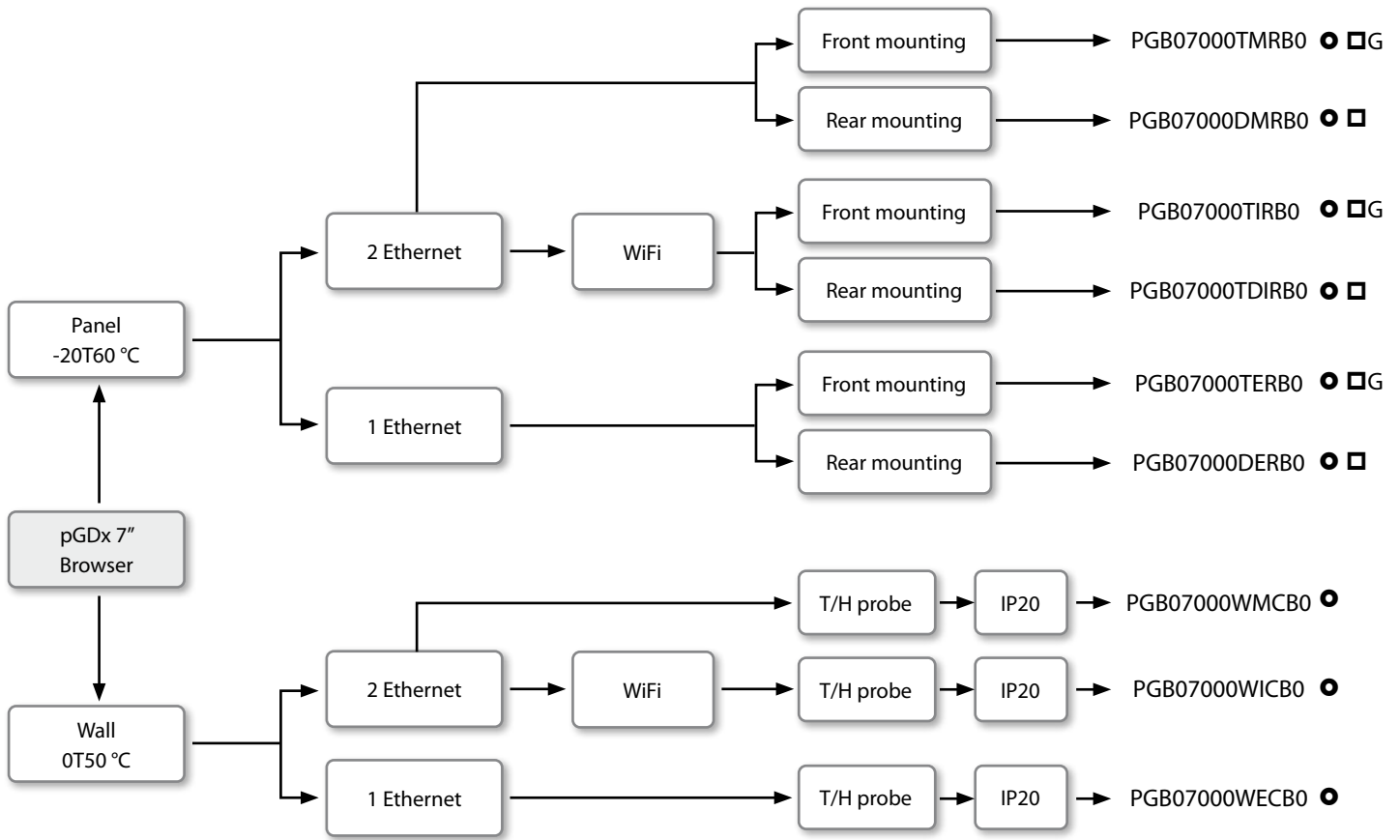

● Front USB

□ Rear USB

G gasket

pGDx 7" runtime

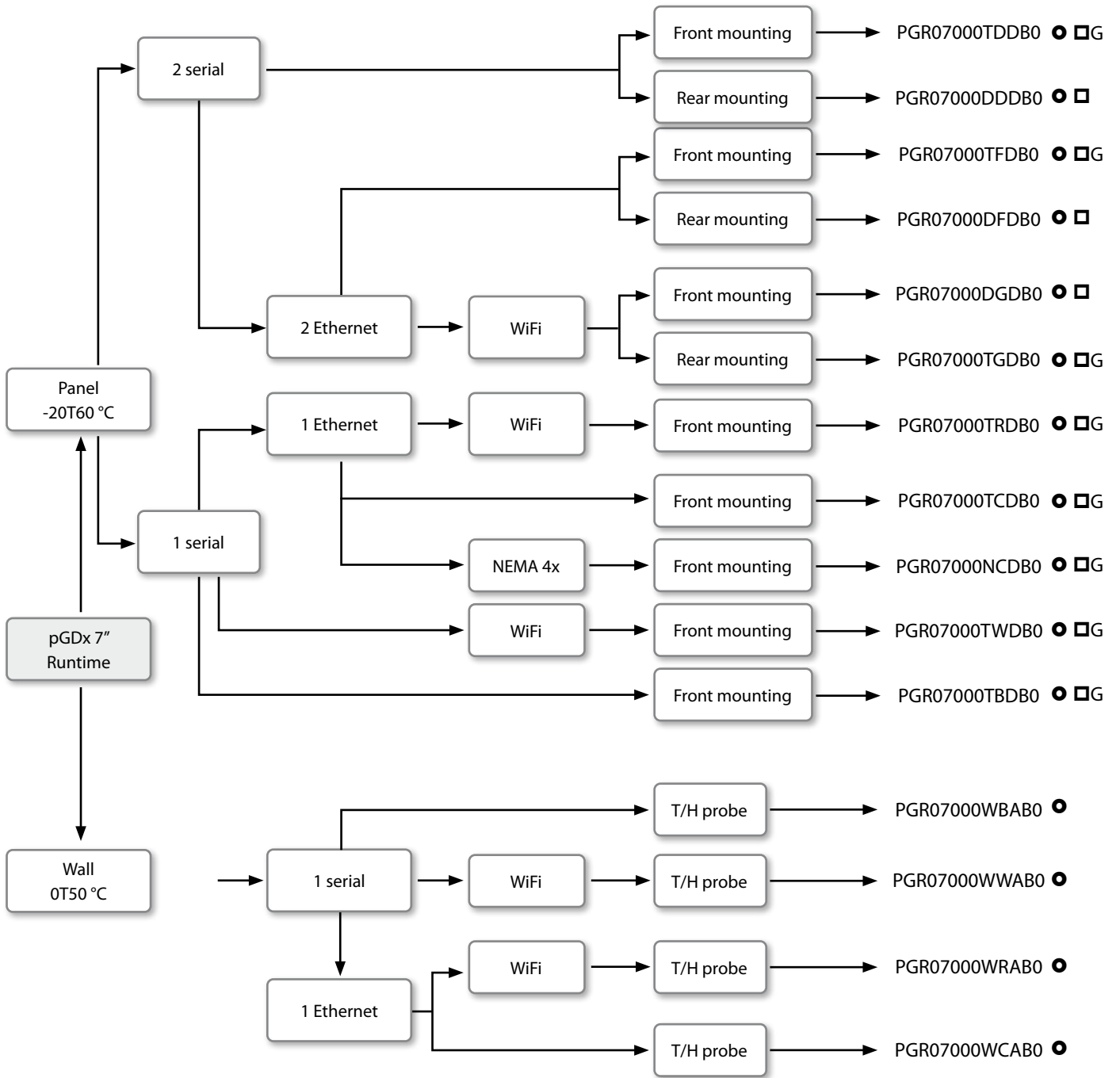



pGDn

PGDN*

The pGDN semi-graphic terminals are part of the c.pCO sistema range of user interfaces, designed to offer higher versatility and greater customisation capabilities.

When developing these terminals, CAREL paid special attention to simple programming and high-quality performance, while maintaining a high aesthetic standard.

These terminals feature a 132x64 pixel display with WHITE backlighting and a 6-button keypad.

They can display graphic symbols in different sizes and the main international alphabets. These terminals follow the

same the logic of flexibility and ease of customisation as the CAREL pCO/c.pCO sistema family products, offering the most demanding customers several low-cost customisation options, even with limited quantities.

Connection to the pCO/c.pCO controller is provided via the RS485 network using the pLAN protocol.

Dimensions (mm)

Wall version

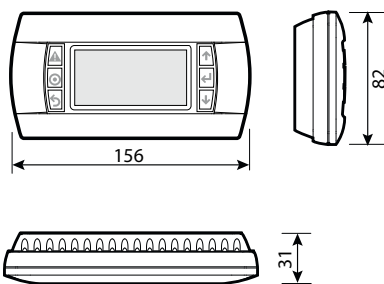

Built-in version

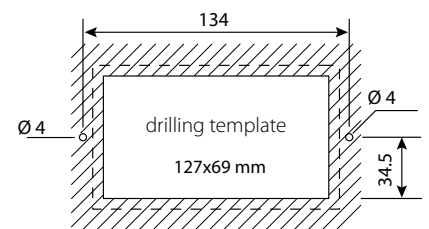
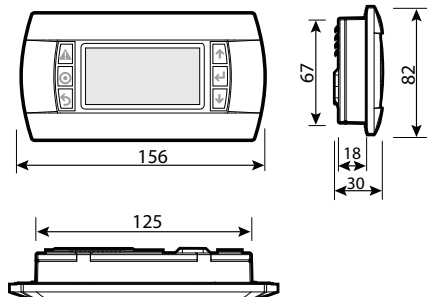



pLDPRO

PLD*

pLDPRO is the best solution for all those applications where cost and compact dimensions are the main requirements.

Compact pCO/c.pCO family LCD display, fully compatible with all of the software and hardware applications developed for pGD1, with 132x64 pixel resolution. pLDPRO provides users a complete set of information, in a clear and customisable way, typical of applications created for programmable LCDs, yet not available on 7-segment LED displays.

With its LCD screen, pLDPRO can display icons (defined at an application software development level) and manage double-height international fonts. The screens can be browsed using the six buttons, with audible signals provided by the buzzer.

Dimensions (mm)

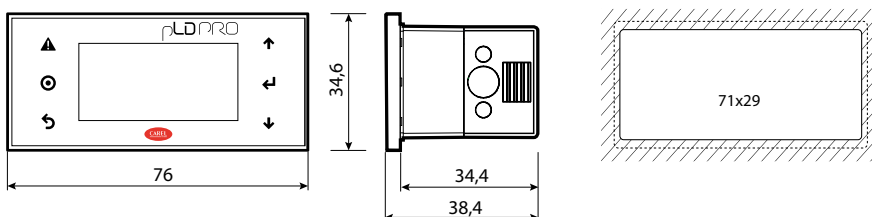

th-tune

ATC*

th-Tune is the CAREL pCO sistema family room terminal that allows users to set the room temperature and humidity in residential applications. Depending on the model, it can be equipped with a temperature probe or a temperature and humidity probe, and is available with 230 Vac or 24 Vac/Vdc power supply. It is compatible with the main recessed wall boxes on the market (IT, USA, DE, CN). Setting the temperature and humidity is simple and intuitive way using the front knob with rotary encoder. The knob also provides users the possibility to change some settings for the room, such as operating mode and time bands. The control mode and information displayed always depend on the connected controller. Its small footprint and elegant design allow easy adaptability to all types of environments. Connection to the pCO controller is provided via the RS485 network using the Modbus protocol.

Dimensions (mm)

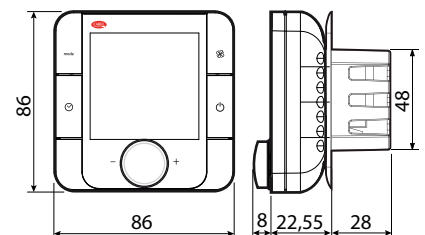

Technical specifications table

Specifications	pGDn	plDPRO	th-tune
General			
Power supply	power supply from pCO via telephone connector or external 18/30 Vdc source protected by 250 mA fuse	pLAN port: power supply from pCO via telephone connector (18-30Vdc class II only);	ATA*: 230 Vac (-15/+10 %) 50/60 Hz ATC*: 24 Vac (-15/+10%), 22-35 Vdc
Maximum power consumption	0.9 W	0.5 W	
Operating conditions	-20T60 °C, 90% rH non-condensing	-20T60 °C, 90% rH non-condensing	-10T60°C, 10 to 90% rH non-cond.
Storage conditions	-20T70 °C, 90% rH non-condensing	-20T70 °C, 90% rH non-condensing	-20T70°C, 10 to 90% rH non-cond.
Ingress protection	IP65 with panel mounting IP40 with wall mounting	IP65	IP20 (enclosure)
Certification			
Class of protection against electric shock	To be incorporated in class I or II appliances	To be incorporated in class I or II appliances	to be incorporated in class I or II appliances
PTI of insulating material	PCB: PTI 250; insulation material PTI 175	175	PCB: from 175 to 249; insulation material: PTI 275
Period of electrical stress	long	long	long
Heat and fire resistance category	D	category D and B	D
Surge protection immunity	Category II	category II	category II
Environmental pollution	2	2	2
Assembly	panel and wall (depending on the P/N)	panel	<ul style="list-style-type: none"> • AT*: panel • AT*: built-in
Connections	telephone connector on the rear of the terminal	telephone connector on the rear of the terminal	fixed connectors
Serial port	pLAN	pLAN	1 RS485

Part number table

Part number	Description
pGDn	
PGNE000F00	pGDn1 132x64, white backlighting, panel mounting
PGNE000W00	pGDNE 132x64, white backlighting, wall mounting
pGDn accessories	
S90CONN000	Telephone connection cable
S90CONN0S0	Connection cable c.pCO mini and k.Air mini
plDPRO	
PLD00GFP00	PLDPRO, 132x64, BUZZER, pLAN CONNECTION
th-tune for wall mounting	
ATC4001AD0	24 Vac, flush mounting
ATC4001CD0	24 Vac, temperature and humidity, flush mounting
ATA4001AW0	230 Vac, wall mounting
ATA4001CW0	230 Vac, temperature and humidity, wall mounting



Sensors and protective devices

Optimum control of an air handling unit requires accurate measurement of the main air conditioning reference parameters.

The CAREL offering thus includes a wide range of temperature, humidity, air quality and pressure probes and sensors, with innovative technological solutions and perfectly in line with the main market standards.



Sensors and protective devices

CAREL offers increasingly advanced and complete global solutions.

This is why CAREL has designed an entire range of probes to meet the needs of HVAC/R installers and manufacturers. The range includes temperature and humidity sensors for different applications, in housings, installed in ducts, residential or industrial environments, pressure transducers, smoke, fire and flood detectors and air quality probes, guaranteeing high performance and compatibility with all CAREL controllers.

The range has been implemented with the most innovative technological solutions, offering new international standards at increasingly competitive prices.

In addition to featuring recognised outstanding performance, CAREL probes are highly versatile and can satisfy a diverse variety of market needs. All of the probes are in fact specially designed to be compatible not only with all CAREL controllers, but also with the most commonly-used standards in the world. The temperature and humidity probes are available with the choice of active or passive technology, different operating ranges and even specific

versions for corrosive or polluting environments. The pressure transducers are available in the 0 to 5 V ratiometric and 4 to 20 mA versions, as well as in the sealed version (to be installed directly in the piping, without a capillary tube) with better performance in terms of precision.

The air quality sensors offer AHU installers and manufacturers an important new accessory with renowned CAREL quality.

Benefits

- Complete range
- International standards
- Analogue or serial communication



Available on CPQ!

CAREL CPQ is the product selection and configuration tool designed to make the work of designers, customers and partners faster and simpler.



Active temperature, humidity & temperature/humidity probes

DPW*: for room installation
DPD*: for duct installation

These probes are especially suitable for civil and commercial environments where special care to the design is needed.

These are used in ducted heating and air conditioning systems. The range also includes models with RS485 connection using the CAREL or Modbus® protocol.

Technical specifications

Power supply: 12/24 Vac -10/15%
9-30 Vdc ±10%

Operating conditions:

- DPW*: -10T60 °C, <100% rH non-cond.;
- DPD*: -10T60 °C, -20T70, <100% rH non-cond.

Ingress protection:

- DPW*: IP30;
- DPD*: IP55, sensor IP40.

Mounting:

- DPW*: wall;
- DPD*: duct;

Number of I/Os:

- **analogue outputs:** -0.5-1 V, 0-1 V, 0-10 V, 4-20 mA

Serial ports: RS485 (specific model)

Dimensions:

- DPW*: 127x80x30 mm;
- DPD*: 98x105x336 mm.

Connections: screw terminal block for wires up to 1.5 mm²



Active temperature/humidity probes for industrial environments

DPP*: for industrial environments

Specifically designed to measure high humidity levels with high accuracy. The range also includes models with RS485 connection using the CAREL or Modbus® protocol.

Technical specifications

Power supply: 12/24 Vac (-10-15%),
9-30 Vdc (±10%)

Operating conditions: -10T60 °C,
-20T70, <100% rH non-cond.

Ingress protection:

- IP55 (container);
- IP54 (sensor)

Mounting: wall

Number of I/Os:

- **analogue outputs:** -0.5-1 V, 0-1 V, 0-10 V, 4-20 mA

Serial ports: RS485 (specific model)

Dimensions: 98x170x44

Connections: screw terminal block for wires up to 1.5 mm²



T/H, CO₂, VOC, PM 2.5, PM10 air quality

DPWQ*: for room installation
DPPQ*: for duct installation

These probes analyse air quality by measuring all of the main parameters, such as CO₂ (carbon dioxide), VOC (volatile organic compounds) and PM 2.5-10 (fine dust). They are also available in the all-in-one version (temperature, humidity, CO₂, VOC and PM 2.5-10) with Modbus RS485 serial communication, providing all the required measurements in just one sensor.

Technical specifications

Power supply: 24 Vac/dc ±10%, 50/60 Hz

Operating conditions: 0T50°C, 10/90% rH non-cond.

Ingress protection:

- IP55 (container);
- IP67 (sensor)

Mounting:

- DPWQ*: wall;
- DPPQ*: duct

Number of I/Os:

- **analogue outputs:** 0-10 V, 4-20 mA or RS485 Modbus

Display: built-in, optional

Serial ports: RS485

Dimensions:

- DPWQ*: 95x97x30 mm; 79x81x26 mm;
- DPPQ*: 108x70x262.5 mm; 64x72x228.4 mm.

Connections: screw terminal block for wires up to 1.5 mm²



Temperature probes with NTC thermistor

NTC*HP*, NTC*WP*, NTC*WH*, NTC*WF*, NTC*HF and NTC*HT, NTCINF*, NTC*PS*

CAREL offers a range of sensors for its controllers, with different characteristics and suitable for different applications, mainly in the HVAC/R sector.

Precision ensured by the technical solutions adopted in constructing the sensor, and reliability resulting from extensive testing make CAREL NTC probes ideal low-cost transducers for measuring temperature.

They are available for installation in housings, on piping or as piercing probes, with or without pre-heater, to measure product core temperature, and with a sensor to estimate product temperature.

Technical specifications

Operating conditions: -50T105 °C

Ingress protection: IP67 and IP68

Mounting: depending on the model

Dimensions: depending on the model



Immersion probes

TSN* and TSC* = NTC version
TST* and TSM* = PT1000 version
TSOPZ = accessories (connectors, fittings, housings...)

CAREL offers the TS* series NTC and PT1000 immersion probes, suitable exclusively for hydronic applications. Fast installation, quick sensor response and excellent price/performance ratio are the main features of this product range. Connectors are available with cables, fittings and housings as accessories.

Technical specifications

Operating conditions: -40T90 °C, -40T120 °C

Mounting: on piping

Dimensions:

- TSN* and TSC*: 1/8" GAS x 5 mm
- TST* and TSM: M14 x 23 mm with 2 m cable



Temperature probes with PTC, PT100, PT1000 sensor

PTC*

PTC temperature probes can be used in both refrigeration and heating applications, to measure temperatures in the range -50T100 °C and 0T150 °C.

PT100*

PT100 probes are the perfect solution for all applications where temperatures need to be measured across an extended range, from -50 to 400 °C (depending on the model).

PT1*HP*, PT1*WP*, PT1*WF*, PT1*HF*, PT1*HT*; PT1*PS; TSQ*

PT1000 probes (PT1* and TSQ*) are suitable for all applications where temperatures need to be measured across an extended range, from -50 to 250 °C (TSQ*) and from -50 to 105 °C (PT1*), ensuring accuracy even when installed remotely over long distances.

Technical specifications

Operating conditions: -50T105 °C, -50T250 °C, -50T350 °C

Ingress protection: IP65 and IP67

Dimensions: depending on the model



C and D series 4-20 mA pressure transducers

SPKT*C*, SPKT*D*

These pressure transducers provide an analogue current signal (4-20 mA). They are mostly used in refrigeration and air conditioning applications to measure the pressure in refrigeration circuits, however their high performance makes them also suitable for other applications. Compatible with all types of refrigerants. Available with male and female connectors in the C series, and female only in the D series.

Technical specifications

Power supply: 8-28 Vdc $\pm 20\%$

Operating conditions:

- -25T80 °C (male);
- -40T135 °C (female).

Ingress protection: IP65 (IP67 with built-in connector)

Number of I/Os:

- **analogue outputs:** 4 to 20 mA

Dimensions: depending on the model

Connectors: Packard



S series 0-5 V ratiometric pressure transducers

SPKT*S*

Type S (sealed) 5 V ratiometric pressure transducers are used for commercial refrigeration and air conditioning applications. They are hermetically-sealed and can be installed in direct contact with the piping, even with refrigerant fluid below dew point (no capillary tubing needed between the piping and the sensor). Available with female connector only.

Technical specifications

Power supply: 5 Vdc

Operating conditions: -40T125 °C

Ingress protection: IP67

Number of I/Os:

- **analogue outputs:** 0.5 - 4.5 V

Dimensions: Ø21x51 mm

Connectors: Packard



P series 0-5 V ratiometric pressure transducers

SPKT*P*

These pressure transducers provide a 0-5 V ratiometric signal (automotive standard). Used in air conditioning and refrigeration systems, except for circuits using ammonia. The excellent stability of the output signal and high degree of EMC/EMI immunity ensure these excellent transducers meet the most stringent industrial requirements. Available with female connectors.

Technical specifications

Power supply: 4.5 to 5.5 Vdc

Operating conditions: -40T135 °C

Ingress protection: IP65

Number of I/Os:

- **analogue outputs:** 0.5 - 4.5 V

Dimensions: 20x51.6 mm

Connectors: Packard



Differential pressure transducers

SPKD*

Differential pressure transducers use a ceramic sensor that supplies a calibrated, temperature-compensated voltage or current signal. They are particularly suitable for measuring low pressure values in air-conditioning systems, rooms, laboratories and clean rooms (air and non-corrosive gases).

Main features:

- compact construction;
- quick and easy installation;
- model configurable for 4 different pressure ranges.

Technical specifications

Power supply: 15 to 36 Vdc

Operating conditions: 0T50 °C

Ingress protection: IP65

Mounting: panel

Number of I/Os:

- **analogue outputs:** 4 to 20 mA

Dimensions: 70x108x73.5 mm

Connections: screw terminal block for wires up to 1.5 mm²



Differential pressure switch

DCPDO*0*00

Device for measuring the differential air pressure for filters, fans, air ducts, air-conditioning and ventilation systems. The pressure switch is particularly suitable for control and safety functions in air-conditioning systems, signalling when fans stop and the filters are blocked. Used in environments with non-aggressive and non-flammable air and gas; also available in the version with assembly kit.



Frost thermostat

DCTF000320

Manages the protection of heat exchangers (evaporator coils) and electric heaters for air-conditioning and refrigeration systems.

It can be used in all applications where the temperature needs to be controlled at a certain point in the system, to prevent it from falling below a pre-defined safety value.

The thermostat also offers self-protection in the event of sensor failure.



Flood detector

FLOE*

Flood detectors measure the presence of water in an environment. When the sensor comes into contact with water, an alarm is immediately activated on the detector and the relay switches status.



Air flow switch

DCFL000100

Flow switch for controlling the flow of air or non-aggressive gases inside the distribution ducts in air-conditioning or air handling systems.

Indicates when there is no flow or restricted flow in the duct by activating a switch.



Smoke and fire detector

SFF*

Smoke and fire detectors are electronic devices that readily detect dangerous and sudden changes in temperature or an increase in smoke. Their main feature is auto-calibration, meaning they retain accuracy over time, adapting perfectly to different environmental conditions without losing sensitivity.

Overview drawing

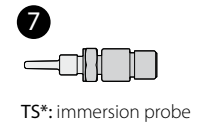
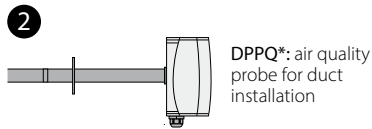
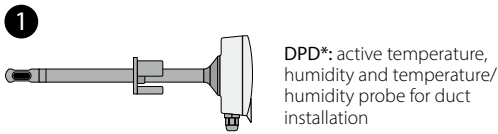
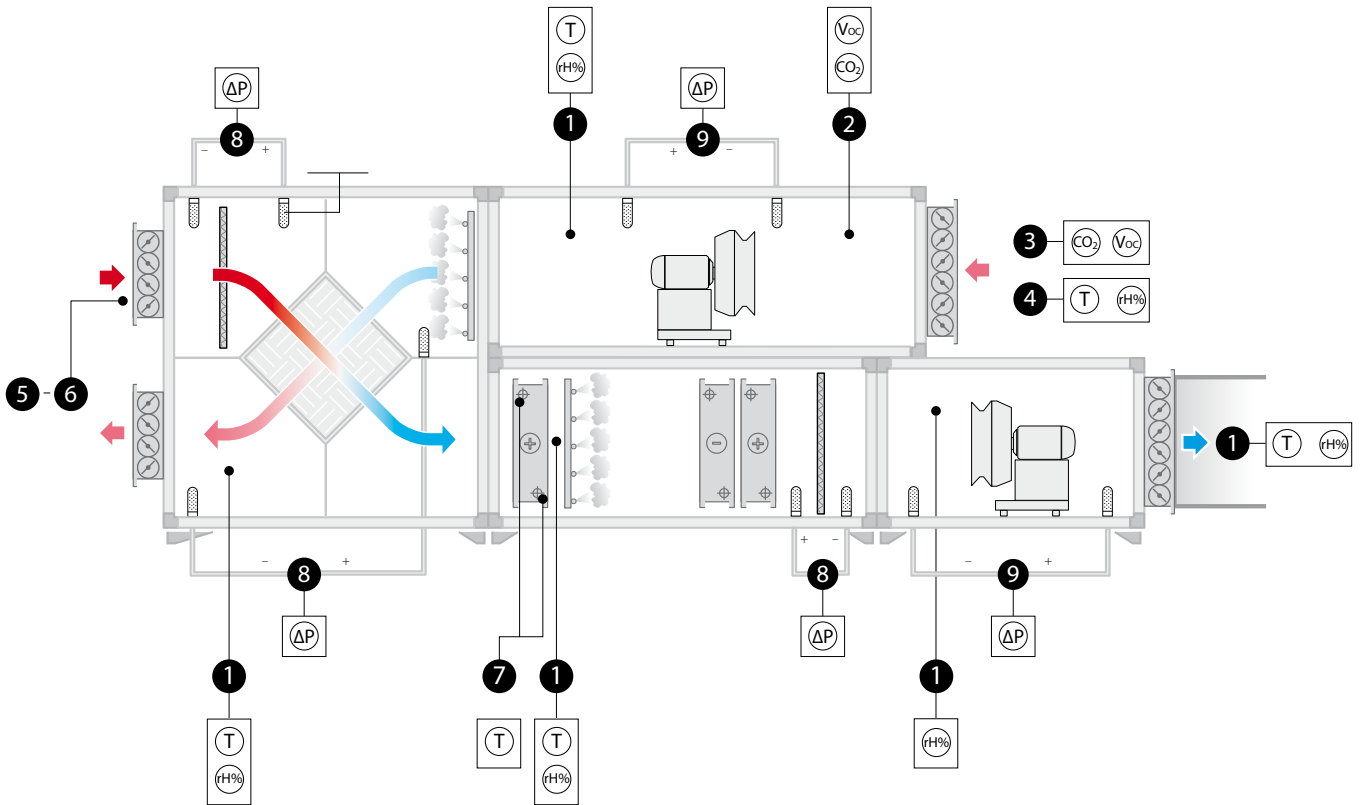

Active temperature and humidity probes

Models	temp. range	measurement range	output
Active room probes with 9-30 Vdc/12-24 Vac power supply			
DPWT010000	-10T60 °C		sel. 0-1 V/-0.5-1 Vdc/4-20 mA
DPWT011000	-10T60 °C		NTC 10 K at 25 °C
DPWC111000	-10T60 °C	10-90% rH	• NTC 10 K at 25 °C (temperature) • sel. 0-1 V/-0.5-1 Vdc/4-20 mA (humidity)
DPWC110000	-10T60 °C	10-90% rH	sel. 0-1 V/-0.5-1 Vdc/4-20 mA
DPWC115000	-10T60 °C	10-90% rH	• NTC 10 K at 25 °C (temperature) • 0 to 10 Vdc (humidity)
DPWC112000	-10T60 °C	10-90% rH	0 to 10 Vdc
DPWC114000	-10T60 °C	10-90% rH	opto-isolated RS485 serial
DPWT014000	-10T60 °C		opto-isolated RS485 serial
Active probes for industrial environments with 9-30 Vdc/12-24 Vac power supply			
DPPT010000	-20T70 °C		sel. 0-1 V/-0.5-1 Vdc/4-20 mA
DPPT011000	-20T70 °C		NTC 10 K at 25 °C
DPPC111000	-10T60 °C	10-90% rH	• NTC 10 K at 25 °C (temperature) • sel. 0-1 V/-0.5-1 Vdc/4-20 mA (humidity)
DPPC110000	-10T60 °C	10-90% rH	sel. 0-1 V/-0.5-1 Vdc/4-20 mA
DPPC210000	-20T70 °C	0-100% rH	sel. 0-1 V/-0.5-1 Vdc/4-20 mA
DPPC112000	-10T60 °C	10-90% rH	0 to 10 Vdc
DPPC212000	-20T70 °C	0-100% rH	0 to 10 Vdc
DPPT014000	-10T60 °C	10-90% rH	opto-isolated RS485 serial
DPPC114000	-10T60 °C	10-90% rH	opto-isolated RS485 serial
DPPC214000	-20T70 °C	0-100% rH	opto-isolated RS485 serial
Active probes for ducts with 9-30 Vdc/12-24 Vac power supply			
DPDT010000	-20T70 °C		sel. 0-1 V/-0.5-1 Vdc/4-20 mA
DPDT011000	-20T70 °C		NTC 10 K at 25 °C
DPDC111000	-10T60 °C	10-90% rH	• NTC 10 K at 25 °C (temperature) • sel. 0-1 V/-0.5-1 Vdc/4-20 mA (humidity)
DPDC110000	-10T60 °C	10-90% rH	sel. 0-1 V/-0.5-1 Vdc/4-20 mA
DPDC210000	-20T70 °C	0-100% rH	sel. 0-1 V/-0.5-1 Vdc/4-20 mA
DPDC112000	-10T60 °C	10-90% rH	0 to 10 Vdc
DPDC212000	-20T70 °C	0-100% rH	0 to 10 Vdc
DPDT014000	-20T70 °C		opto-isolated RS485 serial
DPDC114000	-10T60 °C	10-90% rH	opto-isolated RS485 serial
DPDC214000	-20T70 °C	0-100% rH	opto-isolated RS485 serial
DPUT011000	-50T90 °C		NTC 10 K at 25 °C
DPUC110000	-35T80 °C	0-90% rH	NTC 10 K at 25 °C and 4-20 mA humidity
Compact probe			
DPRC11A000	-10T60 °C	10-90% rH	0.5-4.5 output, 5 V power supply, 1 m cable, humidity - temperature NTC 10 K @ 25 °C
DPRC13A000	-10T60 °C	10-90% rH	0.5-4.5 output, 5 V power supply, 3 m cable, humidity - temperature NTC 10 K @ 25 °C

IP55 container protection for DPD, DPP	(for ducts and equipment rooms)
Sensor protection	IP30 for DPW (wall) IP40 for DPD IP54 for DPP
Time constant, temperature	in still air 300 s in ventilated air (3 m/s) 60 s
Time constant, humidity	in still air 60 s in ventilated air (3 m/s) 20 s

Passive temperature probes

Models	range	precision	constants (time) in fluid	IP
NTC*				
NTCI*HP**	-50T105 °C	25 °C: ±1%	25 s	IP67
NTCI*WF**	-50T105 °C	25 °C: ±1%	10 s	IP67
NTCI*WH**	-50T105 °C	25 °C: ±1%	30 s	IP68 permanent
NT*WG**	-50T105 °C	25 °C: ±1%	20 s	IP67
NT*HT**	0T150 °C	±0.5 °C; -10T50 °C - 25 °C: ±1.0 °C; -50T85 °C ±1.6 °C; +85T120 °C - ±2.1 °C; +120T150 °C	30 s	IP55
NT*HF**	-50T90 °C	±0.5 at 25 °C; ±1.0 °C from -50T90 °C	50 s	IP55
NT**WS*	-40T105 °C	25 °C; ±1%	50 s	IP67
NTC*PS*	-50T105 °C	25 °C: ±1%	50 m	IP67
NTCINF	-50T110 °C	25 °C: ±1%	45 s	IP67
TSN*	-40T120 °C	25 °C: ±1%	30 s	IP68
TSC*	-40T90 °C	25 °C: ±1%	45 s	IP68
PT100*				
PT100000A1	-50T250 °C	IEC 751 class B	20 s	IP65
PT100000A2	-50T400 °C	IEC 751 class B	20 s	IP65
PT1000				
PT1*HP*	-50T105 °C	IEC 751 class B	10 s	IP67
PT1*WF*	-50T105 °C	IEC 751 class B	15 s	IP67
PT1*WP*	-50T105 °C	IEC 751 class B	25 s	IP68 limited
PT1*HF*	-50T105 °C	IEC 751 class B	15 s	IP67
PT1*HT*	-50T250 °C	IEC 751 class B	20 s	IP67
PT1*PS*	-50T105 °C	IEC 751 class B	50 m	IP67
TSQ15MAB00	-50T250 °C	IEC 751 class B	10 s	IP65
TST*	-40T120 °C	IEC 751 class B	10 s	IP68
TSM*	-40T90 °C	IEC 751 class B	10 s	IP68
PTC				
PTC0*0000	0T150 °C	±2 °C; 0T50 °C - ±3 °C; -50T90 °C - ±4 °C; 90T120 °C	15 s	IP65
PTC0*W*	-50T100 °C	±2 °C; 0T50 °C - ±3 °C; -50T90 °C - ±4 °C; 90T120 °C	15 s	IP67
PTC03000*1	-50T120 °C	±2 °C; 0T50 °C - ±3 °C; -50T90 °C - ±4 °C; 90T120 °C	15 s	IP67

Air quality sensors

Models	type	output
Room 24 Vac/15-36 Vdc		
DPWQ306000	VOC	0-10 Vdc or 4-20 mA
DPWQ402000	CO2	0 to 10 Vdc
DPWQ502000	VOC and CO2	0 to 10 Vdc
DPWQ60B010	Temperature, rH%	RS485 serial
DPWQ70B010	Temperature, rH% and CO2	RS485 serial
DPWQ80B010	Temperature, rH%, CO2 and VOC	RS485 serial
DPWQ90B010	Temperature, rH%, CO2, VOC, PM2.5 and PM10	RS485 serial
Room with display		
DPWQ61B010	Temperature, rH%	RS485 serial
DPWQ71B010	Temperature, rH% and CO2	RS485 serial
DPWQ81B010	Temperature, rH%, CO2 and VOC	RS485 serial
DPWQ91B010	Temperature, rH%, CO2, VOC, PM2.5 and PM10	RS485 serial
Duct 24 Vac/15-36 Vdc		
DPDQ306000	VOC	0-10 Vdc or 4-20 mA
DPDQ402000	CO2	0 to 10 Vdc
DPDQ502000	VOC and CO2	0 to 10 Vdc
DPDQ60B010	Temperature, rH%	RS485 serial
DPDQ70B010	Temperature, rH% and CO2	RS485 serial

Pressure transducers

Models	power supply	operating temperature	range	precision	output signal	constants (time)	IP
SPKT00-P0: 0-5 V ratiometric - P series female							
53	4.5 to 5.5 Vdc	-40T135 °C	4.2 bars, relative	±1.2%	0.5 - 4.5 V	10 ms	IP65 ¹
13	4.5 to 5.5 Vdc	-40T135 °C	9.3 bars, relative	±1.2%	0.5 - 4.5 V	10 ms	IP65 ¹
33	4.5 to 5.5 Vdc	-40T135 °C	34.5 bars, relative	±1.2%	0.5 - 4.5 V	10 ms	IP65 ¹
43	4.5 to 5.5 Vdc	-40T135 °C	17.3 bars, relative	±1.2%	0.5 - 4.5 V	10 ms	IP65 ¹
B6	4.5 to 5.5 Vdc	-40T135 °C	45.0 bars, relative	±1.2%	0.5 - 4.5 V	10 ms	IP65 ¹
F3	4.5 to 5.5 Vdc	-40T135 °C	20.7 bars, relative	±1.2%	0.5 - 4.5 V	10 ms	IP65 ¹
E3	4.5 to 5.5 Vdc	-40T135 °C	12.8 bars, relative	±1.2%	0.5 - 4.5 V	10 ms	IP65 ¹
SPK*C*: 4-20 mA - C series female							
*T0021C0	8 to 28 Vdc	-40T135 °C	-0.5 to 7 bars	±1% fs; 0T50 °C	4 -20 mA	<10 ms	IP65 ¹
*T0011C0	8 to 28 Vdc	-40T135 °C	0 to 10 bars	±1% fs; 0T50 °C	4 -20 mA	<10 ms	IP65 ¹
*T0031C0	8 to 28 Vdc	-40T135 °C	0 to 30 bars	±1% fs; 0T50 °C	4 -20 mA	<10 ms	IP65 ¹
*T0041C0	8 to 28 Vdc	-40T135 °C	0 to 18.2 bars	±1% fs; 0T50 °C	4 -20 mA	<10 ms	IP65 ¹
*T00B1C0	8 to 28 Vdc	-40T135 °C	0 to 44.8 bars	±1% fs; 0T50 °C	4 -20 mA	<10 ms	IP65 ¹
*T00G1C0	8 to 28 Vdc	-40T135 °C	0 to 60 bars	±1% fs; 0T50 °C	4 -20 mA	<10 ms	IP65 ¹
*T00D8C0	8 to 28 Vdc	-40T100 °C	0 to 150 bars	±1% fs; 0T50 °C	4 -20 mA	<10 ms	IP65 ¹
*T00M8C0	8 to 28 Vdc	-40T100 °C	0 to 120 bars	±1% fs; 0T50 °C	4 -20 mA	<10 ms	IP65 ¹
SPK*: 4-20 mA - D series female							
*T0021D0	8 to 28 Vdc	-40T135 °C	-0.5 to 7 bars	±1% fs; 0T40 °C	4 -20 mA	<10 ms	IP65
*T0011D0	8 to 28 Vdc	-40T135 °C	0 to 10 bars	±1% fs; 0T40 °C	4 -20 mA	<10 ms	IP65
*T0041D0	8 to 28 Vdc	-40T135 °C	0 to 18.2 bars	±1% fs; 0T40 °C	4 -20 mA	<10 ms	IP65
*T0031D0	8 to 28 Vdc	-40T135 °C	0 to 30 bars	±1% fs; 0T40 °C	4 -20 mA	<10 ms	IP65
*T00B1D0	8 to 28 Vdc	-40T135 °C	0 to 44.8 bars	±1% fs; 0T40 °C	4 -20 mA	<10 ms	IP65
*T00G1D0	8 to 28 Vdc	-40T135 °C	0 to 60 bars	±1% fs; 0T40 °C	4 -20 mA	<10 ms	IP65
SPK*: 0-5 V - S series female							
*T0051S0	0.5 to 4.5 Vdc	-40T125 °C	-1 to 4.2 bars	±1% fs; 0T50 °C	0.5 - 4.5 V	<10 ms	IP67
*T0011S0	0.5 to 4.5 Vdc	-40T125 °C	-1 to 9.3 bars	±1% fs; 0T50 °C	0.5 - 4.5 V	<10 ms	IP67
*T00E1S0	0.5 to 4.5 Vdc	-40T125 °C	-1 to 12.8 bars	±1% fs; 0T50 °C	0.5 - 4.5 V	<10 ms	IP67
*T0041S0	0.5 to 4.5 Vdc	-40T125 °C	0 to 17.3 bars	±1% fs; 0T50 °C	0.5 - 4.5 V	<10 ms	IP67
*T00F1S0	0.5 to 4.5 Vdc	-40T125 °C	0 to 20.7 bars	±1% fs; 0T50 °C	0.5 - 4.5 V	<10 ms	IP67
*T0031S0	0.5 to 4.5 Vdc	-40T125 °C	0 to 34.5 bars	±1% fs; 0T50 °C	0.5 - 4.5 V	<10 ms	IP67
*T00B1S0	0.5 to 4.5 Vdc	-40T125 °C	0 to 45 bars	±1% fs; 0T50 °C	0.5 - 4.5 V	<10 ms	IP67
*T00G1S0	0.5 to 4.5 Vdc	-40T125 °C	0 to 60 bars	±1% fs; 0T50 °C	0.5 - 4.5 V	<10 ms	IP67
*T00L1S0	0.5 to 4.5 Vdc	-40T125 °C	0 to 90 bars	±1% fs; 0T50 °C	0.5 - 4.5 V	<10 ms	IP67
SPK*DO*: 4-20 mA - D series male							
*10000D0	8/28 Vac	-25T80 °C	-0.5 to 7 bars	±1% fs	4 -20 mA	-	IP67
*24000D0	8/28 Vac	-25T80 °C	-1 to 24 bars	±1% fs	4 -20 mA	-	IP67
*30000D0	8/28 Vac	-25T80 °C	0 to 30 bars	±1% fs	4 -20 mA	-	IP67

¹ with built-in IP67 connector

Differential air pressure transducers

Models	power supply	power consumption	differential pressure range	differential pressure precision full scale	output signal	filtered signal	IP
SPKD00C5N0	15 to 30 Vdc	≥20 mA	-50 to 50 Pa -100 to 100 Pa 0 to 50 Pa 0 to 100 Pa	±3%	4-20 mA	selectable, 1 or 10 s	IP65
SPKTD00U5N0	15 to 30 Vdc	≥20 mA	0 to 1000 Pa 0 to 2000 Pa 0 to 3000 Pa 0 to 5000 Pa	±3%	4-20 mA	selectable, 1 or 10 s	IP65

Pressure switches and flow switches

operating conditions	sensor	range	precision	maximum current	output signal	contact type	IP
DCPD0*0100: pressure switch for ducts							
-25T85 °C max 50 mbar	silicone membrane	0.5 to 5 mbars	0.2 ± 15% mbars	1.5 (A) 25 Vac 0.1 A 24 Vac	NO / NC voltage-free contact.	sealed switch AgCdO contacts	IP54
DCPD0*1100: pressure switch for ducts							
-20T85 °C max 50 mbar	silicone membrane	0.2 to 2 mbars	0.2 ± 15% mbars	1.5 (A) 25 Vac 0.1 A 24 Vac	NO / NC voltage-free contact.	sealed switch AgCdO contacts	IP54
DCFL000100: flow switches							
-40T85 °C	silicone membrane	2.5 to 9.2 m/s (start) 1 to 8 m/s (stop)		15 (8) A 24/250 Vac	NO / NC voltage-free contact.	sealed switch	IP65

*: "1" with mounting kit



Humidifiers

Since it was founded in 1973, CAREL has been at the cutting-edge in the research and development of new technological solutions for controlling air humidity.

Our product portfolio now includes all humidification technologies, so as to offer the best high-quality product for your application. Humidification and control know-how combine together to create reliable humidifiers with advanced control logic that are easy to use and service.



Isothermal humidifiers

Isothermal humidification is the most common way to control air relative humidity.

This works by delivering steam directly into a flow of air; the steam is immediately absorbed, thus increasing the humidity while keeping the temperature virtually constant.

Isothermal humidifiers differ in terms of the steam production technology used, such as immersed electrodes, heaters and gas-fired burners, each with its own specific features in terms of performance, reliability and operating costs.

CAREL has been at the forefront of humidification technologies for over 40 years and offers an extensive range of isothermal humidifiers for each type of technology.

The range is completed by distribution systems and accessories that can meet the requirements of all applications.



Available on CPQ!

CAREL CPQ is the product selection and configuration tool designed to make the work of designers, customers and partners faster and simpler.

Benefits

- Hygienically safe
- Reduced installation space
- Suitable for small and medium humidification loads
- Air temperature remains constant
- Can work on tap water or treated water



humiSteam

UE*

humiSteam is a versatile solution, suitable for many applications, from civil to industrial environments. It is a humidifier designed for installation in air ducts, using high-efficiency linear steam distributors. humiSteam works on mains water, and its control software automatically adjusts operation based on the characteristics of the feedwater, so as to extend operation without maintenance. The main benefits of humiSteam are:

- patented AFS system (Anti Foaming System) that detects and manages foam to prevent droplets of water being carried by the steam;
- cylinders with plug-in power connectors for easy, fast and risk-free maintenance;
- quick start and a wide range of feedwater conductivity, for higher performance;
- built-in conductivity sensor and control software to optimise energy efficiency and operating life, with constant performance over the life of the cylinder;
- modulating limit probe for maximum safety in AHUs/ducts;

“Basic” (UE*Y)

This is the simplest solution for all steam humidification applications. Available in sizes from 1 to 65 kg/h, it is supplied with a basic electronic controller (Y) and a display, with the following features:

- ON/OFF or proportional control (voltage or current) based on an external signal;
- flow-rate modulation: 20 - 100%;
- adjustable maximum capacity;
- cylinder lifetime hour counter;
- automatic draining due to inactivity, so as to guarantee hygiene;
- complete diagnostics with memory;
- signal types: 0-10 V; 0-20 mA; 4-20 mA, NTC, 0-10 V; 2-10 V.

“Xplus” (UE*X)

Premium immersed electrode humidifier. Equipped with a type “X” controller, based on pCO technology, and LCD display and keypad for programming and control. Available in sizes from 1.5 up to 130 kg/h, it can control steam production in the following modes:

- ON/OFF control proportional to an external signal (voltage or current), plus safety limit probe in the duct;
- modulating based on the set point, humidity probe reading and duct limit probe reading;
- modulating based on the set point and outside temperature probe reading (e.g. steam baths);
- continuous modulation of steam flow-rate from 20 to 100% of maximum production (10% - 100% in the 90 and 130 kg/h models):
- daily and weekly programming;
- alarm log management.

Cylinders

The performance of immersed electrode humidifiers depends on the number and shape of the electrodes.

humiSteam comes with a wide choice of cylinders, specific for water with conductivity between 75 µS/cm and 1250 µS/cm, for flow rates between 1 and 65 kg/h and for power supply voltages between 208 V and 575 V.

All humiSteam cylinders are fitted with galvanised electrodes and filters to prevent scale build-up on the bottom and thus preventing the drain from blocking.

humiSteam table

Specifications	UE001*	UE003*	UE005*	UE008	UE009*	UE010*	UE015*	UE018*	UE025*	UE035*	UE045*	UE065*	UE090*	UE130*	
General															
Rated steam production - kg/h	1.5	3	5	8	9	10	15	18	25	35	45	65	90	130	
Power consumption - kW	1.12	2.25	3.75	6.00	6.75	7.50	11.25	13.5	18.75	26.25	33.75	48.75	67.5	97.5	
Power supply (other voltages on request)	•	•	•		•	•	•		•	•	•				
• 200, 208-230 Vac -15/10%, 50/60 Hz single-phase	•	•	•		•	•	•		•	•	•				
• 200, 208, 230 Vac -15/10%, 50/60 Hz three-phase		•	•	•		•	•	•	•	•	•	•	•	•	
• 400, 460, 575 Vac -15/10%, 50/60 Hz, three-phase		•	•	•		•	•	•	•	•	•	•	•	•	
Steam connection - mm	Ø 22/30		Ø 30					Ø 40			Ø 2x40		Ø 4x40		
Outlet pressure limits - Pa	-600 to 1500		-600 to 1300		-600 to 1350			-600 to 2000							
Number of cylinders	1												2		
Operating conditions	-1T40°C, 10-90% rH non-condensing														
Storage conditions	-10T70°C, 5-95% rH non-condensing														
Ingress protection	IP20														
Certification	CE, ETL (UL998), TÜV and EAC (GOST)														
Water fill															
Connection	3/4"G male														
Temperature limits - °C	1T40														
Water pressure limits - MPa (bars)	0.1 to 0.8 - 1 to 8														
Instant flow rate - l/m	0.6	0.6	0.6	0.6	1.1	1.1	1.1	1.1	5.85	5.85	5.85	7	14	14	
Total hardness - °fH (*)	10 to 40														
Conductivity limits - µS/cm (*)	75 to 1250														
Water drain															
Connection	Ø 40														
Temperature - °C	≤100														
Instant flow rate - l/m	8								22				44		
Blower															
Number	1										2		4		
Type	VSDU0A*								VRDXL*						
Power supply - Vac	24								230						
Rated power - W	37								120						
Nominal air flow-rate - m³/h	192								576						
Network															
Built-in network connections	UEX*, UEY* and UEW*: Modbus®, CAREL protocol														
Optional network connections	UEX*, UEY* and UEW*: Modbus, BacNET RS485, BacNET Ethernet, LON, KONNEX (for UEY* using a gateway)														
Controller	UEY* / UEX* / UEW*												UEX*		

• standard

Dimensions in mm (in) and weights in kg (lbs)

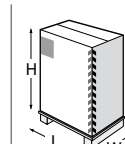
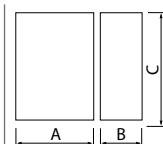

Mod.	AxBxC	weight	LxWxH	weight
UE001 - UE018	365x275x712 (14.37x10.83x28.03)	13.5 (29.76)	500x400x850 (19.68x15.75x33.46)	16 (35.27)
UE025 - UE045	545x375x815 (21.46x14.76x32.09)	34 (74.95)	665x465x875 (26.18x18.31x34.45)	39 (85.98)
UE065	635x465x890 (25x18.31x35.04)	44 (97)	750x600x940 (29.53x23.62x37.01)	51 (112.43)
UE090 - UE130	1150x465x890 (45.27x18.31x35.04)	70 - 74 (154.32 - 163.14)	1270x600x940 (50x23.62x37.01)	77 - 81 (169.75 - 178.57)

Part number

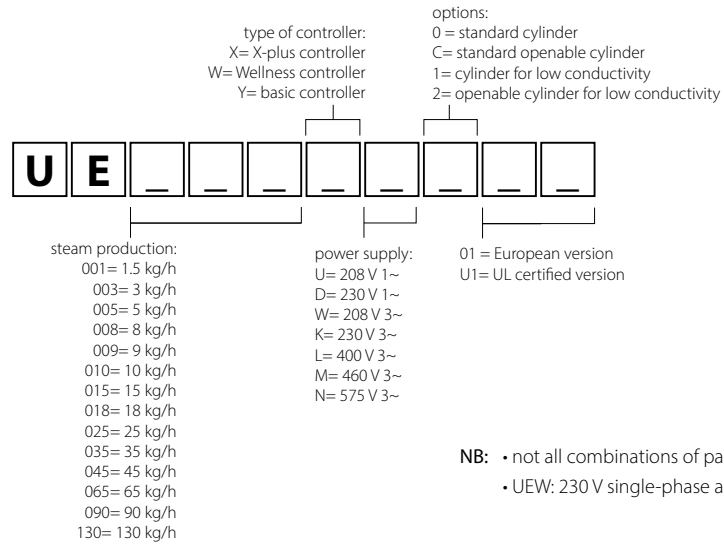

Overview humiSteam Y-X-W

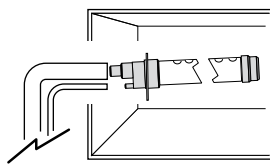

DP*: linear steam distributor (inlet Ø 22 mm, Ø 30 mm, Ø 40 mm), for duct applications

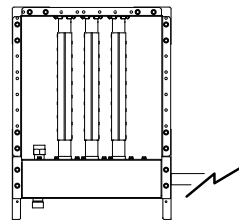

SA*: steam distributor for short absorption distances

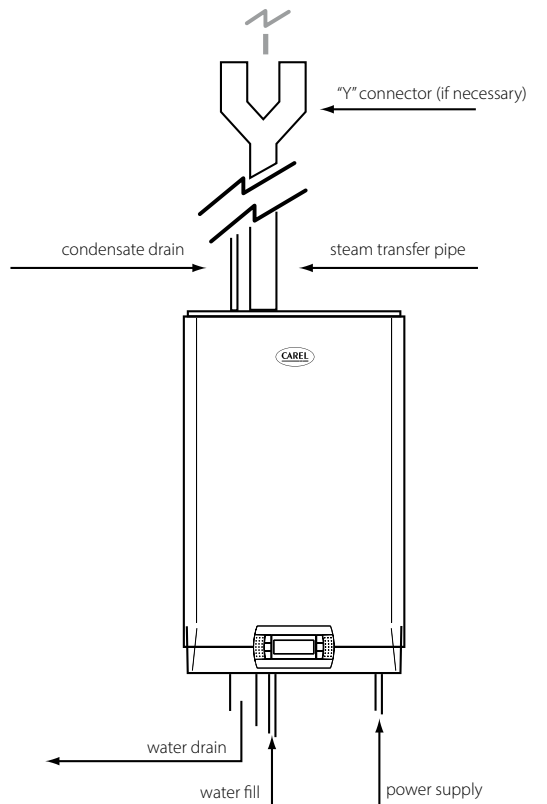

Probes



DPW*: temperature and humidity probe for civil environments



DPP*: temperature and humidity probe for industrial environments



ASET*: temperature and humidity probe for steam baths

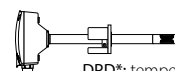

DPD*: temperature and humidity probe for ducts



NTC*: temperature probe for UEW



heaterSteam

UR*

The new range of CAREL heaterSteam heater humidifiers continues the evolution of steam humidification technologies. heaterSteam combines the most advanced humidity control technology with the potential of connectivity, offering a product that is unrivalled on the market in terms of precision, reliability and simple management.

The innovations involve every aspect of the product, from the mechanical components to electronics, with a new 4.3" touchscreen graphic interface and electronic controller based on the c.pCO platform.

The new software functions make heaterSteam even more reliable and versatile, while the connectivity features allow seamless integration into higher-level BMS systems.

heaterSteam is available in two versions: **process** and **titanium**.

heaterSteam process

This model has heaters made from Incoloy® 825, a highly-resistant material that allows operation in complex conditions, even when feedwater quality is not controlled.

heaterSteam titanium

The world's only humidifier with titanium heaters. The reliability of titanium heaters makes heaterSteam titanium the natural solution for applications where continuity of operation is crucial. In particular, it can operate with treated water of any quality, even extremely aggressive water with conductivity below 1 $\mu\text{S}/\text{cm}$, and softened water down to 0° fH: the titanium heaters are completely immune to corrosion.



User interface

The new heaterSteam range makes human interaction with the unit simple and intuitive.

The heaterSteam models can be equipped with a 4.3" touch graphic terminal. This new terminal, through a series of graphic pages with colourful and animated icons, allows quick and easy management of the unit, as well as giving the product an innovative and technological feel.

Furthermore, the titanium version is also available with built-in webserver, for configuration and monitoring of the humidifier from any PC or mobile device connected to the same local network

Controller

The heaterSteam electronic controller, called c.pHC, has been designed and developed by CAREL for simple commissioning and installation, so as to quickly obtain excellent performance. Steam production can be set based on relative humidity (H) or temperature (T) for steam bath applications. With the exception of ON/OFF mode, modulation of production is linear from 0 to 100% of maximum flow-rate, with an accuracy of $\pm 1\%$ rH

heaterSteam table

Specifications	UR002*	UR004*	UR006*	UR010*	UR013*	UR020*	UR027*	UR040*	UR053*	UR060*	UR080*	
General												
Rated steam production - kg/h	2	4	6	10	13	20	27	40	53	60	80	
Power consumption - kW	1.6	3.3	4.7	7.4	10	15.1	20	30.5	40	45.7	60	
Power supply (other voltages on request)	●	●	●									
• 230 Vac -15/10%, 50/60 Hz single-phase			●	●	●	●	●	●	●	●	●	
• 400 Vac -15/10%, 50/60 Hz three-phase			●	●	●	●	●	●	●	●	●	
Steam connection - mm	Ø 30					Ø 40			2x Ø 40			
Steam pressure - Pa	0 to 1500					0 to 2000						
Number of heaters	1	1	3	3	3	6	6	6	6	9	9	
Operating conditions	-1T40°C, 10-60% rH non-condensing											
Storage conditions	-10T70°C, 5-95% rH non-condensing											
Ingress protection	IP20											
Certification	CE, ETL (UL998), TÜV and EAC (GOST)											
Water fill												
Connection - mm	3/4"G male											
Temperature limits - °C	1T40											
Water pressure limits - MPa; bars	0.1 - 0.8; 1 - 8											
Instant flow rate - l/m	1.1	1.1	1.1	1.1	1.1	4	4	4	10	10	10	
Total hardness - °fH (*)	5 to 40											
Conductivity limits - µS/cm	0 to 1500											
Water drain												
Connection	Ø 40					Ø 50						
Temperature - °C	<100											
Instant flow rate - l/m	5 (50 Hz); 9 (60 Hz)					17.5 (50 Hz); 22.5 (60 Hz)						
Blower												
Number	1								2			
Type	VSDU0A*					VRDXL*						
Power supply - Vac	24					230						
Rated power - W	37					120						
Nominal air flow-rate - m³/h	192					576						
Network												
Network connections	Modbus RTU and TCP/IP BACnet MS/TP and IP											
Controller												
Continuous modulation (with SSR)	0 to 100%											
Built-in control (probes not included)	rH or temperature											
Proportional to external signal	●											
Limit probe supported	●											
Remote ON/OFF	●											
Alarm relay	●											
Signal type (probe or external controller)	0-10 V; 0-1 V; 2-10 V; 0-20 mA; 4-20 mA											
Supervisor (via RS485 and Ethernet)	●											

(*) heaterSteam can be supplied with completely demineralised water (1 µS/cm). If supplied with softened water, observe the minimum hardness value and follow the instructions shown in the manual.

● standard

Features

Specifications	Process	Titanium
User interface	4.3" touchscreen or LCD with 6 buttons	4.3" touchscreen
Heaters with thermal protection	Incoloy® 825	Titanium
Thermal shock	●	●
Main/secondary functions	"Mirror" ¹	"Endurance" ²
Redundancy and rotation		●
Wireless probes		●
Websaver		●
BACnet™, Modbus® and CAREL protocols	●	●
USB port	●	●
Cloud-based monitoring service	● ³	● ³
Preheating	●	●
Cylinder thermal insulation		●
Kevlar scale liner		●
Start-up Wizard	●	●
Evaporation cycles before drain to dilute	40	50 ⁵

● standard

- Using the "mirror" function, the heaterSteam process main unit can extend its capacity by managing up to 19 secondary units, which faithfully replicate the status of the main unit
- Using the "Endurance" function, heaterSteam titanium can manage a further 19 units via Ethernet. This feature includes redundancy, rotation and maintenance functions, a major innovation: imagine an installation with three UR units, each with a capacity of 80 kg/h: during maintenance on one of the units, the other two will compensate for the momentary absence by increasing their steam production.
- The tDisplay remote supervisory service, included, allows the user to monitor and interact with the unit from wherever they are, simply by connecting the humidifier to the internet, via Ethernet cable or UMTS.
- Up to UR013
- heaterSteam titanium, exploiting the mechanical characteristics of the heaters, is the only humidifier on the market that can reach 50 consecutive evaporation cycles without requiring a drain to dilute cycle! (The market standard is 40 cycles).

Dimensions in mm (in) and weights in kg (lb)

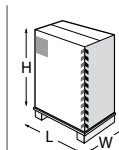
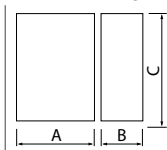

Mod.	AxBxC	weight	LxWxH	weight
UR002*, UR013*	365x275x712 (14.37x10.83x20.03)	26 (57.32)	510x410x870 (20x16x34.2)	31 (68.34)
UR020*, UR040*	690x445x888 (27.16x17.51x34.96)	63 (138.89)	820x570x1050 (32.2x22.4x41.3)	73 (160.94)
UR053*, UR080*	876x445x888 (34.48x17.51x34.96)	87 (191.80)	990x540x1050 (39x21.2x41.3)	98 (216.05)

Part number

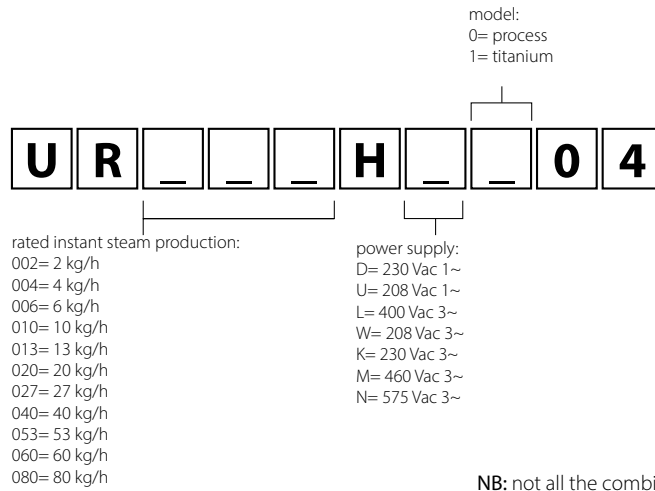

NB: not all the combinations of codes are available.

Overview heaterSteam

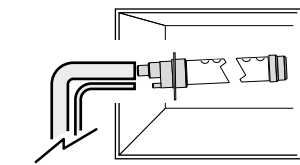

DP*: linear steam distributor (inlet Ø 22 mm, Ø 30 mm, Ø 40 mm), for duct applications

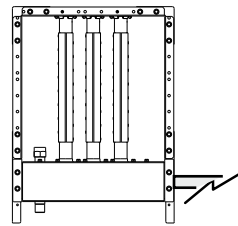

SA*: steam distributor for short absorption distances

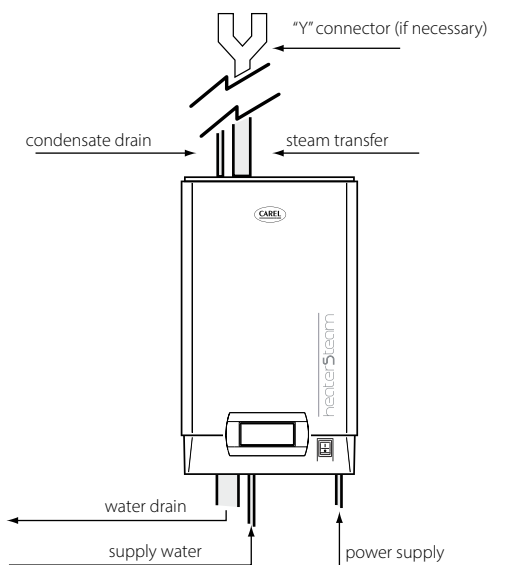

Probes



DPP*: temperature and humidity probe for industrial environments

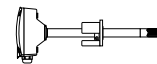

DPD*: temperature and humidity probe for ducts



DPW*: temperature and humidity probe for civil environments



SA*: room temperature and humidity sensor - wireless



WS01AB2M20: access point - wireless



indoor



outdoor



gaSteam

UG*H* e UG*Y*

The gaSteam humidifier family features very high thermal efficiency, taking full advantage of the cost savings when using gas as the fuel.

The heat exchanger has been designed to increase performance even with particularly aggressive feedwater: stainless steel design for high performance.

The default communication protocols on gaSteam units are: Modbus® BACnet™ and Carel on the BMS serial port; Modbus® and BACnet™ also on the Ethernet port. The controller can be connected to an active probe and an optional limit probe; operation is ON/OFF or proportional to an external control signal. A complete set of diagnostics is also provided for maintenance.

Outdoor version

To ensure full operation in all weather conditions, gaSteam is also available in the outdoor version (-20 to 45 °C / -4 to 112 °F). The unit is fully assembled in the factory and can be equipped with frost protection heaters. The outdoor version eliminates the risk of having a source of gas inside the building, and can also be used when no space is available indoors. The base is raised to avoid the stagnation of water and simplify handling by forklift.

Controller

gaSteam humidifiers come with the brand new c.pHC microprocessor electronic controller, based on the CAREL programmable c.pCO. The user interface features a 4.3" touchscreen graphic display, which improves the user experience through instant information and easy navigation, with graphic icons and texts in various languages. The CAREL pGDx display allows complete management of the humidifier functions even by inexperienced users, thanks to the colour graphic display and animated icons.

gaSteam table

Specifications	UG045*	UG090*	UG150*	UG180*	UG300*	UG450*
General						
Rated steam production - kg/h (lbs/h)	45 (100)	90 (200)	150 (330)	180 (400)	300 (660)	450 (1000)
Steam production modulation	25 to 100%	25 to 100%	25 to 100%	12.5 to 100%	12.5 to 100%	12 to 100%
Gross heat input - kW	34.8	65	108	130	216	324
Net heat output - kW	33	62.5	105	125	210	315
Power supply	230 Vac 50 Hz (ver. UG***YD004)/ 115V 60 Hz (ver. UG***Y1104)					
Power consumption at rated voltage - W	180	250	260	385	400	660
Steam outlet pressure limits - Pa (psi)	0 to 2000 (0 to 0.30)					
Steam connection Ø - mm (in)	1x80 (2x3.15)		1x80 (1x3.15)	2x80 (2x3.15)	2x80 (2x3.15)	3x80 (3x3.15)
Gas connection	1x1"G	1x1"G	1x1"G	1x1" 1/4G	1x1" 1/4G	1x1" 1/4G
Types of gas	natural gas, LPG					
Natural gas (G20) flow-rate/pressure - m ³ St/h (Pa)	3.68 (2000)	6.87 (2000)	11.45 (2000)	13.4 (2000)	22.7 (2000)	34.4 (2000)
Natural gas (G25) flow-rate/pressure - m ³ St/h (Pa)	4.2 (2000)	8.7 (2000)	14.6 (2000)	17.5 (2000)	29.2 (2000)	43.8 (2000)
Butane (G30) flow-rate/pressure - m ³ St/h (Pa)	1.10 (3000)	2.06 (3000)	3.43 (3000)	4.12 (3000)	6.86 - 3000	10.29 - 3000
Operating conditions	Indoor: 1T40°C (33T104 F); 10-90% rH non-cond. Outdoor: -40T45°C (-40T113F); 10-90% rH non-cond					
Storage conditions	-10T70°C, 5-95% rH non-cond.					
Ingress protection	Indoor: IP20 Outdoor: IAS 12-94					
Certification	CE, ETL (UL998), TÜV and AGA In addition for the outdoor version: ETL in accordance with IAS standard (No. 12-94) for outdoor installations.					
Water fill						
Connection	1x3/4"G male					2x3/4"G male
Temperature limits	1T45°C(34T113°F);					
Water pressure limits - MPa; bars (psi)	0.1 - 0.8; 1 - 8 (14.5 - 166)					
Fill valve instant flow rate - l/m (gallUS/min)	18 (4.76)					
Total hardness - °fH (*)	4 to 40					
Maximum conductivity limits - µS/cm (*)	1500					
Water drain						
Connection Ø - mm (in)	50 (1.97)					
Temperature - °C (°F)	<100 (212)					
Instant flow rate - l/m (gallUS/min)	32 (8,45)					
Flue gas						
Exhaust flue Ø - mm (in)	80 (3)	80 (3)	80 (3)	2x 80 (3)	2x 80 (3)	3x80 (3)
Flue connection Ø - mm (in)	80 (3)	80 (3)	80 (3)	2x 80 (3)	2x 80 (3)	3x80 (3)
Flue gas flow-rate (natural gas G20) - kg/s	0.0163	0.0303	0.048	0.606	0.096	0.144
Flue gas temperature (natural gas G20) - °C (° F)	135 (253)	170 (338)	175 (342)	165 (329)	168 (334)	168 (334)
NOx emissions class	5	5	5	4	4	4
Network						
Network connections	Modbus® RTU and TCP/IP; BACnet MS/TP and IP					
Controller						
Continuous modulation	25-100% (12.5-100% for 180 and 300 kg/h units)					
Built-in control (probes not included)	rH or temperature					
Proportional to external signal	●					
Limit probe supported	●					
Remote ON/OFF	●					
Alarm relay	●					
Signal type (probe or external controller)	0-10 V; 0-1 V; 2-10 V; 0-20 mA; 4-20 mA					
Supervisor (via RS485 and Ethernet)	●					

(*) gaSteam can be supplied with completely demineralised water (0°fH). If supplied with softened water, observe the minimum hardness value and follow the instructions shown in the manual.

- standard

Features

Specifications	All versions
User interface	4.3" touchscreen
Main/secondary functions	"Mirror"1, "Endurance"2
Redundancy and rotation	●
Wireless probes	●
Websserver	●
BACnet™, Modbus® and CAREL protocols	●
USB port	●
Cloud-based monitoring service	● ³
Preheating	●
Advanced preheating	● ⁴
Start-up Wizard	●
Evaporation cycles before drain to dilute	max. 40
High heat exchanger efficiency	up to 96%
Precision	±2%
Flame sensor	●
Drain tempering kit (optional)	●
Frost protection function	●

● standard

- Using the "mirror" function, the gaSteam main humidifier can extend its capacity by managing up to 19 secondary units, which faithfully replicate the status of the main unit
- Using the "Endurance" function, gaSteam can manage a further 19 units via Ethernet. This feature includes redundancy, rotation and maintenance functions, a major innovation: imagine an installation with three UG units, each with a capacity of 90 kg/h: during maintenance on one of the units, the other two will compensate for the momentary absence by increasing their steam production.
- The tDisplay remote supervisory service, included, allows the user to monitor and interact with the unit from wherever they are, simply by connecting the humidifier to the internet, via Ethernet cable or UMTS.
- In main/secondary systems with "grouped" rotation, if the "advanced preheating" function is active, when the request reaches 90% of production (on the units correctly in production), preheating is activated on the remaining units.

Dimensions in mm (in) and weights in kg (lb)

Mod.	indoor version				outdoor version			
	AxBxC	weight	LxWxH	weight	AxBxC	weight	LxWxH	weight
UG045*	1443x656x1603 (57x26x63)	255 (562)	1486x706x1470	255 (562)	1560x800x1603 (61x31x63)	270 (595)	1486x706x1470	270 (595)
UG090*	1443x656x1603 (57x26x63)	255 (562)	1486x706x1470	255 (562)	1560x800x1603 (61x31x63)	270 (595)	1486x706x1470	270 (595)
UG150*	1443x656x1603 (57x26x63)	255 (562)	1486x706x1470	255 (562)	1560x800x1603 (61x31x63)	270 (595)	1486x706x1470	270 (595)
UG180*	1443x993x1603 (57x39x63)	355 (783)	1486x1086x1470	355 (783)	1560x1107x1603 (61x44x63)	370 (816)	1486x1086x1470	370 (816)
UG300*	1443x993x1603 (57x39x63)	355 (783)	1486x1086x1470	355 (783)	1560x1107x1603 (61x44x63)	370 (816)	1486x1086x1470	370 (816)
UG450*	-	-	-	-	1620x1668x1603 (64x66x63)	550 (1213)	1486x1086x1470	550 (1213)

Part number

type of controller:
 H= indoor installation 1T45°C (34T113°F)
 Y= outdoor installation 1T45 °C(34T113 °F)
 X= outdoor modulating -40T45 °C (-40T113 °F) UL

NB: not all the combinations of codes are available

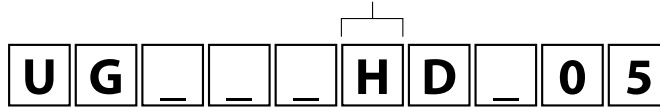

rated instant steam production kg/h:	supply voltage:	Frequency:
045= 45 kg/h (100 lbs/h)	D= 230 Vac 1ph	0= 50 Hz
090= 90 kg/h (200 lbs/h)	1= 115 V 1ph	1= 60 Hz
150= 150 kg/h (330 lbs/h)		
180= 180 kg/h (400 lbs/h)		
300= 300 kg/h (660 lbs/h)		
450= 450 kg/h (990 lbs/h)		

Overview gaSteam

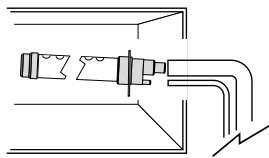

DP*0: linear steam distributor (inlet Ø 22 mm, Ø 30 mm, Ø 40), for duct applications
DP*H: high-efficiency linear steam distributor (inlet Ø 30 mm, Ø 40), reduces condensation by 20% compared to DP*0 linear distributors

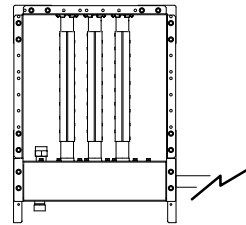

SA*: steam distributor for short absorption distances

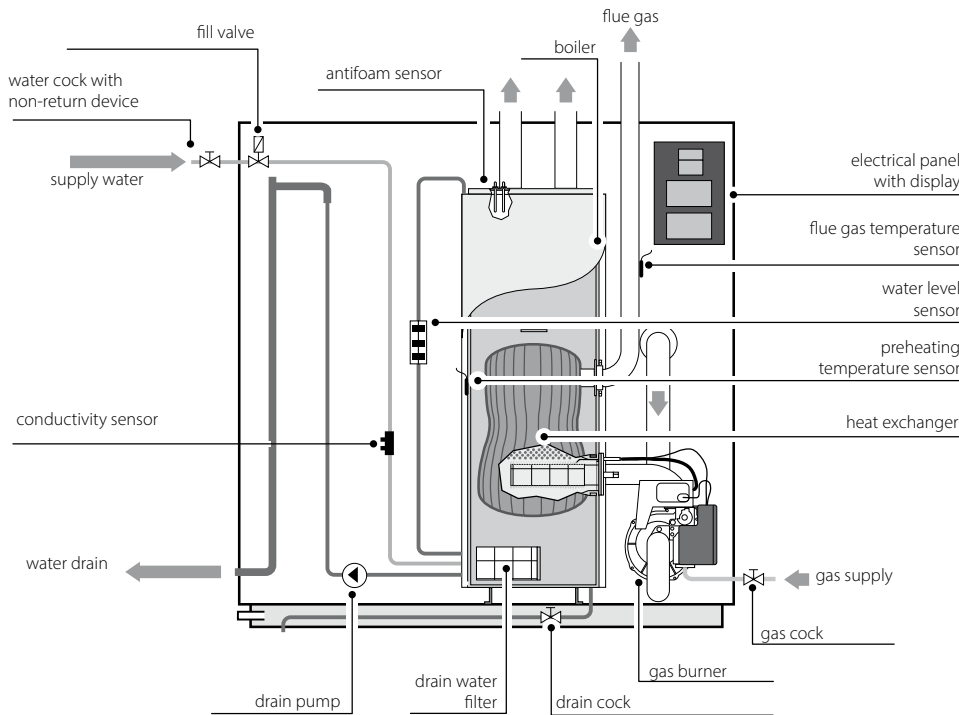

Probes

DPW*: temperature and humidity probe for civil environments

DPP*: temperature and humidity probe for industrial environments

ASET*: temperature and humidity probe for steam baths

DPD*: temperature and humidity probe for ducts



ultimateSAM

SAB*, SAT*

ultimateSAM is a pressurised or atmospheric-pressure steam distributor, designed to distribute dry steam uniformly and efficiently in ducts or air handling units. SAM stands for Short-Absorption Manifold, meaning a steam distributor with a short absorption distance (even less than 300 mm).

ultimateSAM can be used both connected to a pressurised steam network and to steam generators operating at atmospheric pressure (isothermal humidifiers). When connected to a pressurised steam distribution network, the fluid reaches the distributor via a control valve, which expands the steam until it reaches atmospheric pressure.

When steam is supplied at atmospheric pressure, no valve is required and production is managed directly by the humidifier.

Different ultimateSAM configurations are available to manage applications with high steam flow-rates, always with a short absorption distance (even less than 300 mm).

It has been designed to be “made to measure” for the AHU or duct, while ensuring low air heat gain (max. 2 °C/4 °F).

All of the metal parts installed inside the AHU or duct are made from AISI 304 steel, so as to guarantee hygiene and a long operating life. The features of the ultimateSAM steam distribution system make it perfect for all AHU/duct humidification needs, providing designers, installers and service personnel with the best possible solution.

The wide range of products, with a vast choice of steam flow-rates and numerous options, make it the ideal system for various applications, including hospitals and the pharmaceutical industry.

Benefits

- Uniform steam delivery into the duct, so as to guarantee a very short absorption distance;
- Energy saving thanks to insulation of the pipes that minimises the formation of condensate inside the distributor as well as heat gain in the air;
- Hygiene: ultimateSAM is made from AISI 304 steel.



ultimateSAM single pipe

SA0*

This can be used with pressurised steam or steam at atmospheric pressure.

In this case, the manifold acts as a condensate separator, being fitted on the inside with a deflector, as well as a condensate drain. The single pipe is supplied with insulation and nozzles to reduce the condensate formation and the absorption distance.

Accessories available for the single-pipe version:

- SAKC*S10*0: condensate drain pipe kit;
- SAKCO*T0*0: “T” condensate drain connection kit;
- SAKD0*10*0 and SAKD0*20*0: steam inlet kit for double-pipe.

Condensate separator manifold

In the single pipe versions, the manifold acts as a condensate separator. Thanks to the deflector, the steam is forced to follow a path in which it is separated from any condensate drained through the discharge terminal. Only dry steam therefore enters the distributor pipe.

Accessories



Modulating valves (SAKV*)

The modulating valve is required for ultimateSAM when connected to pressurised steam distribution networks. Modulating valve with electric actuator and automatic safety closing in the event of power failure, controls the flow based on the signal from an external controller.



Condensate drain kit (SAKC*S10*0) for SA0*; (SAKC*ST100, SAKC*S1200) for SAB/SAT

Condensate drain connection in stainless steel for single-pipe models. Stainless steel connection and condensate drain pipe for the ultimateSAM Bottom and Top versions.



Steam inlet connections (SAKI*)

The ultimateSAM humidification system includes a variety of steam inlet adapters to ensure maximum installation flexibility. All of the adapters are made of stainless steel and are sized for easy connection to all other system components.



Steam traps, condensate drains and "Y" filters (SAKT*P*, SAKT*D*, SAKT*B*) and (SAKT*F*)

The steam trap + condensate drain assembly prevents condensate from forming in the supply line to the valve and the steam distribution system. The filters remove all types of impurities that may be drawn into the piping.

ultimateSAM table

Models	Description	Maximum steam flow-rate at atmospheric pressure	Maximum pressurised steam flow-rate
SA0*	Single-pipe version	From 20 kg/h to 50 kg/h (44 lbs/h to 110 lbs/h)	From 20 kg/h to 140 kg/h - (44 lbs/h to 308 lbs/h)
SAB*	Multi-pipe version with steam supply from the bottom	From 15 kg/h to 370 kg/h (33 lbs/h to 814 lbs/h)	
SAT*	Multi-pipe version with steam supply from the top	From 60 kg/h to 1110 kg/h (132 lbs/h to 2447 lbs/h)	

Dimensions in mm (in) and weights in kg (lb)

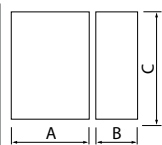

Mod.	AxBxC	weight
SAB*	447x135x598 / 3031x135x3030 (17.60x5.31x23.54 / 119.33x5.31x119.29) - in 152 mm steps	7.5 to 202.5 (17 to 446)
SAT*	447x135x749 / 3031x15x3181 (17.60x5.31x29.49 / 119.33x5.31x125.24) - in 152 mm steps	10 to 213.5 (22 to 470)
SA0*	pipe length 383 - 2055 mm (15.08-80.90) - in 152 mm steps - B = C = 160 mm (6.30)	4 to 8.81 (8.7 to 19.4)

Part number

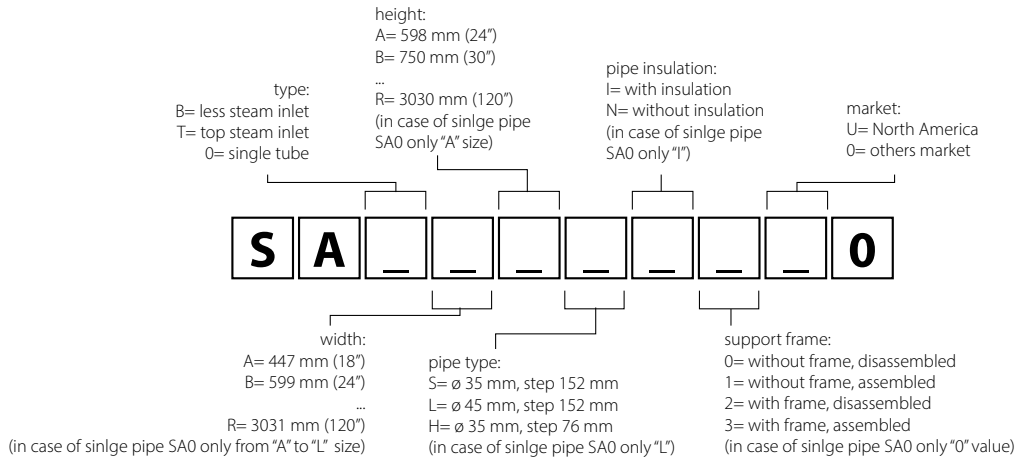

Overview ultimateSAM

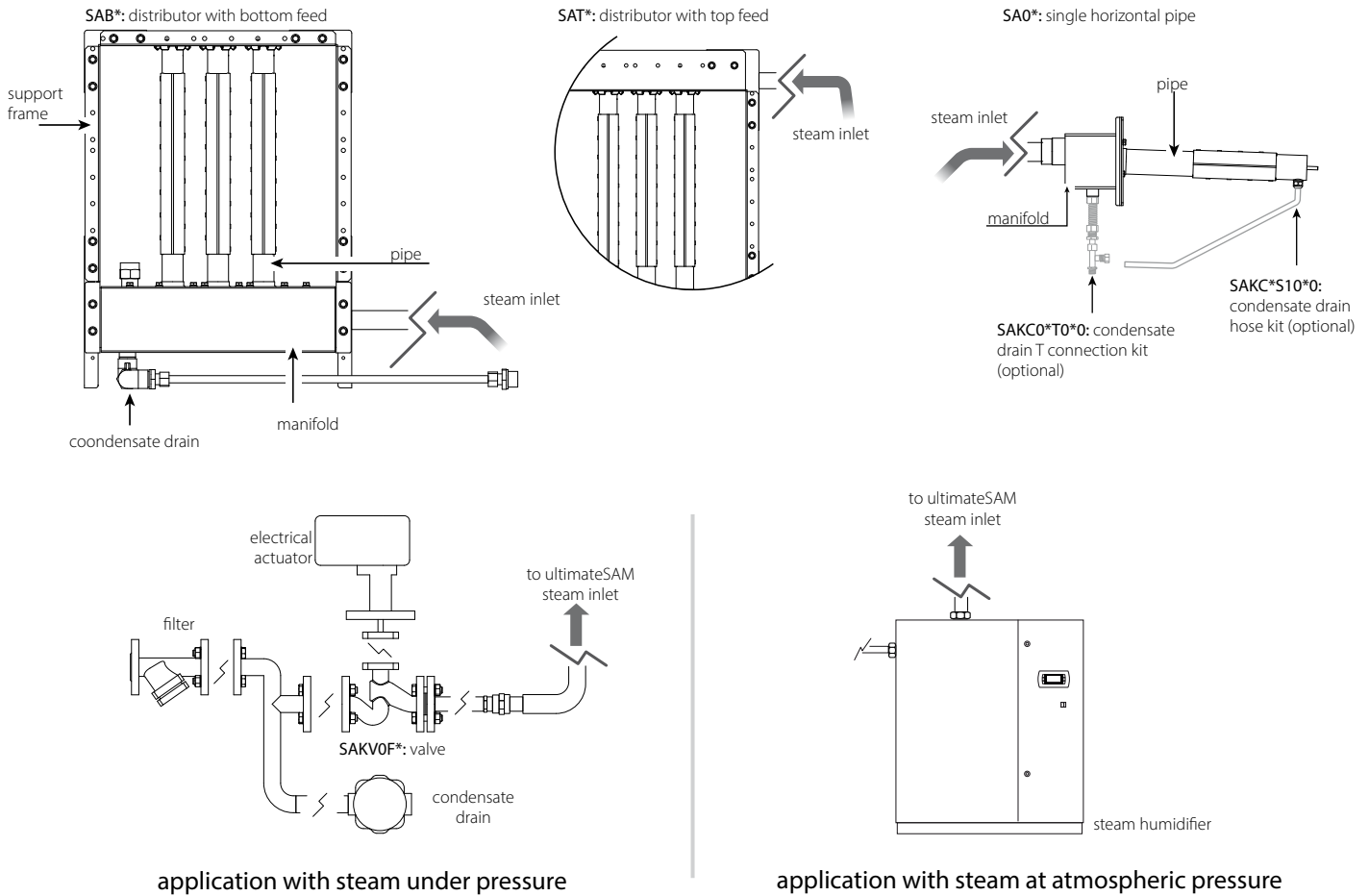



Steam distributors for ducts

DP***D**R*

The wide range of "DP" series linear steam distributors for ducts consists of perforated stainless steel pipes supported by a Ryton® fixing bracket. This material combines excellent mechanical strength with extraordinary resistance to high temperatures. The fixing bracket is used to fix the steam distributor to a vertical wall, ensuring the correct slope of the distributor for condensate drainage. The linear steam distributors are available with three different diameters: 22, 30 and 40 mm. Designed to distribute the steam uniformly over the entire length of the duct, they minimise the absorption distance.



High-efficiency steam distributors

DP*****RH

These new steam distributors complete the current product range, thus providing a response to all customer needs, also in terms of energy savings.

The air cushion, acting as an insulator between the steam pipe and the outer jacket, reduces heat exchange between the hot steam inside the distributor and the lower-temperature air in the duct/AHU: this reduces condensation by at least 20%.

Just like in the other versions, excellent steam distribution is ensured by the modular construction, making it possible to virtually cover all duct/AHU widths and exploit as much air flow as possible.

The lengths range from 350 mm to 2050 mm, in 30 mm or 40 mm diameters.

Typical linear distributor installations

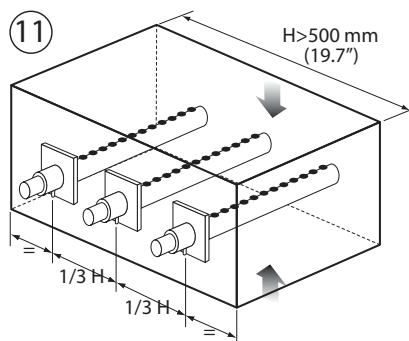
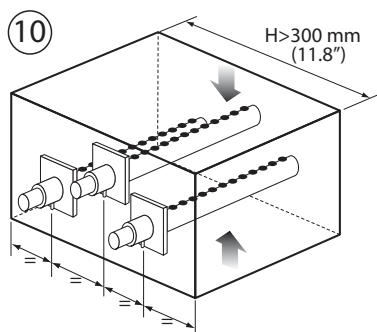
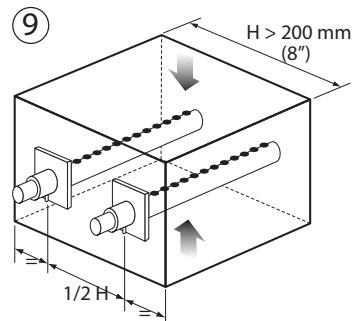
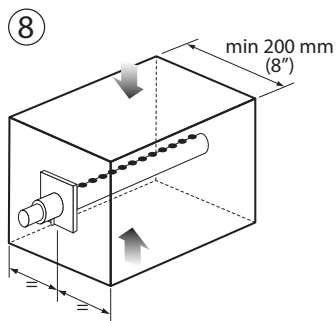
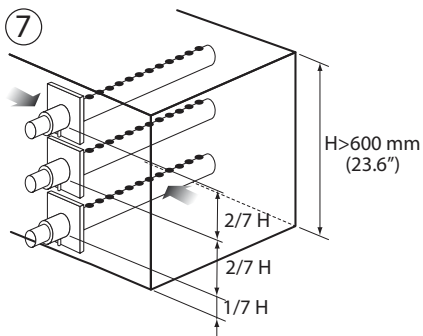
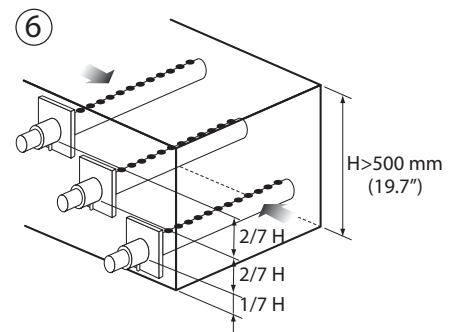
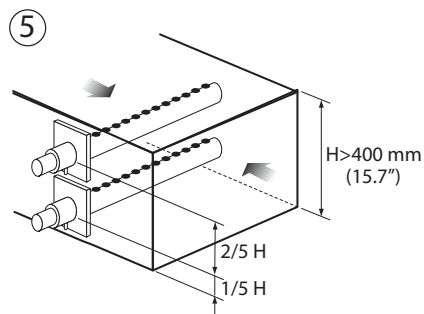
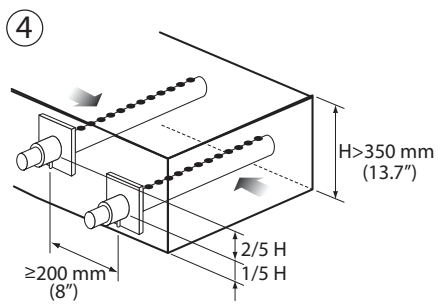
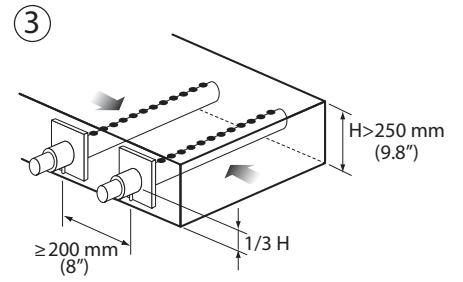
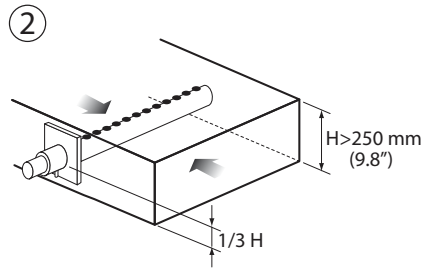
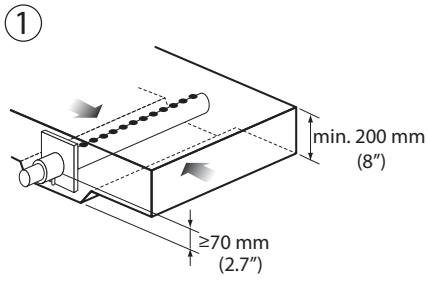

Steam distributor table

distributor inlet mm (in)	max. distributor capacity kg/h (lb/h)	min. duct/AHU width mm (in)	code	humiSteam												
				UE001	UE003	UE005	UE008	UE009	UE010	UE015	UE018	UE025	UE035	UE045		
22 (0.9")	4 (8.8)	350 (13.7")	DP035D22R0	1	1											
22 (0.9")	6 (13.2)	450 (17.7")	DP045D22R0	1	1											
22 (0.9")	9 (19.8)	600 (23.6")	DP060D22R0	1	1											
22 (0.9")	9 (19.8)	850 (33.5")	DP085D22R0	1	1											
30 (1.2")	5 (11)	350 (13.7")	DP035D30R0			1										
30 (1.2")	8 (17.6)	450 (17.7")	DP045D30R0			1	1									
30 (1.2")	12 (26.4)	600 (23.6")	DP060D30R0			1	1	1	1							
30 (1.2")	18 (39.6)	850 (33.5")	DP085D30R0			1	1	1	1	1	1	(2)*	(2)*			
30 (1.2")	18 (39.6)	1050 (41.3")	DP105D30R0			1	1	1	1	1	1	(2)*	(2)*			
30 (1.2")	18 (39.6)	1250 (49.2")	DP125D30R0			1	1	1	1	1	1	(2)*	(2)*			
30 (1.2")	18 (39.6)	1650 (65")	DP165D30R0						1	1	1	(2)*	(2)*			
40 (1.6")	25 (55)	850 (33.5")	DP085D40R0									1	(2)**	(2)**		
40 (1.6")	35 (77)	1050 (41.3")	DP105D40R0									1	1	(2)**		
40 (1.6")	45 (99)	1250 (49.2")	DP125D40R0									1	1	1		
40 (1.6")	45 (99)	1650 (65")	DP165D40R0											1	1	
40 (1.6")	45 (99)	2050 (80.7")	DP205D40R0											1	1	
22 (0.9")	4 (8.8)	300 (11.8")	DP030D22RU	1	1											
30 (1.2")	10 (22)	200 (7.9")	DP020D30RU	1	1	1	1	1	1							
30 (1.2")	15 (33)	300 (11.8")	DP030D30RU			1	1	1	1	1	2 (i)	(2)*				
30 (1.2")	15 (33)	450 (17.7")	DP045D30RU			1	1	1	1	1	2 (i)	(2)*				
30 (1.2")	15 (33)	600 (23.6")	DP060D30RU			1	1	1	1	1		(2)*				
40 (1.6")	45 (99)	600 (23.6")	DP060D40RU									1	1	1		
High-efficiency versions																
30 (1.2")	5 (11)	350 (13.7")	DP035D30RH			1										
30 (1.2")	8 (17.6)	450 (17.7")	DP045D30RH			1	1									
30 (1.2")	12 (26.4)	600 (23.6")	DP060D30RH			1	1	1	1							
30 (1.2")	18 (39.6)	850 (33.5")	DP085D30RH			1	1	1	1	1	1	(2)*	(2)*			
30 (1.2")	18 (39.6)	1050 (41.3")	DP105D30RH			1	1	1	1	1	1	(2)*	(2)*			
30 (1.2")	18 (39.6)	1250 (49.2")	DP125D30RH			1	1	1	1	1	1	(2)*	(2)*			
30 (1.2")	18 (39.6)	1650 (65")	DP165D30RH						1	1	1	(2)*	(2)*			
40 (1.6")	25 (55)	850 (33.5")	DP085D40RH									1	(2)**	(2)**		
40 (1.6")	35 (77)	1050 (41.3")	DP105D40RH									1	1	(2)**		
40 (1.6")	45 (99)	1250 (49.2")	DP125D40RH									1	1	1		
40 (1.6")	45 (99)	1650 (65")	DP165D40RH											1	1	
40 (1.6")	45 (99)	2050 (80.7")	DP205D40RH											1	1	
humidifier capacity kg/h				1	3	5	8	9	10	15	18	25	35	45		
humidifier outlet Ø mm				22 /30 (0.9")/(1.2")		30 (1.2")					40 (1.6")					

NB: if the duct does not feature the required width for the distributor, two shorter distributors (numbers indicated in brackets) can be used, branching the steam hose.

*: use Carel "Y" kit UEKY000000, 40 mm (1.6") inlet and 2 x 30 mm (1.2") outlets

** : use Carel "Y" kit UEKY40X400, 40 mm (1.6") inlet and 2 x 40 mm (1.6") outlets

[a] use Carel kit SAKIT40200, 80 mm (3.1") inlet and 2 x 40 mm (1.6") outlets

[b] use Carel kit SAKIT40400, 80 mm (3.1") inlet and 4 x 40 mm (1.6") outlets

[l] use Carel "Y" kit UEKY000000 and KITVAP3040, 30 mm (1.2") inlet and 40 mm (1.6") outlet

			heaterSteam											gaSteam		
UE065	UE090	UE130	UR002	UR004	UR006	UR010	UR013	UR020	UR027	UR040	UR053	UR060	UR080	UG045	UG090	UG150
			1	1												
			1	1	1											
				1	1	1		(2)*								
				1	1	1	1	(2)*	(2)*							
				1	1	1	1	(2)*	(2)*							
				1	1	1	1	(2)*	(2)*							
						1	1	(2)*	(2)*							
(4)**	(4)**							1	1	(2)**	(4)**	(4)**	(4)**	2 (a)	4 (b)	
2	(4)**	4						1	1	(2)**	2	2	(4)**	2 (a)	4 (b)	
2	2	4						1	1	1	2	2	2	2 (a)	2 (a)	4 (b)
2	2	4							1	1	2	2	2	2 (a)	2 (a)	4 (b)
2	2	4								1	2	2	2	2 (a)	2 (a)	4 (b)
			1	1	1	1										
			1	1	1	1	1	(2)*	(2)*							
			1	1	1	1	1	(2)*	(2)*							
				1	1	1	1	(2)*	(2)*							
2	2	4						1	1	1	2	2	2	2 (a)	2 (a)	4 (b)
			1	1												
			1	1	1											
				1	1	1		(2)*								
				1	1	1	1	(2)*	(2)*							
				1	1	1	1	(2)*	(2)*							
				1	1	1	1	(2)*	(2)*							
(4)**	(4)**					1	1	(2)*	(2)*							
2	(4)**	4						1	1	(2)**	2	2	(4)**	2 (a)	4 (b)	
2	2	4						1	1	1	2	2	2	2 (a)	2 (a)	4 (b)
2	2	4							1	1	2	2	2	2 (a)	2 (a)	4 (b)
2	2	4								1	2	2	2	2 (a)	2 (a)	4 (b)
65	90	130	2	4	6	10	13	20	27	40	53	60	80	45	90	150
2x 40 (1.6")		4x 40 (4x 1.6")	30 (1.2")					40 (1.6")		2x 40 (1.6")			80 (3.1")			





Adiabatic humidifiers

Adiabatic humidifiers bring about direct evaporation of water into the air without requiring an external energy supply; the heat required for evaporation is provided by the warm, humid air, which is thus cooled.

The water evaporates spontaneously due to an increase in the interface surface between the water and the surrounding air; the larger the surface area, the faster the water will evaporate.

The most common method for achieving this is to produce the smallest possible droplets of water. This process is called atomisation or nebulisation. The smaller the diameter of the droplets produced, the higher the evaporation efficiency.

When heating indoors spaces in winter, both isothermal and adiabatic humidification are equally effective, and consequently the choice between the two methods essentially depends on functional and economic considerations.

CAREL has a wide range of adiabatic humidification technologies capable of satisfying the most demanding requirements of ventilation applications, in terms of efficiency, precision and energy consumption.



Available on CPQ!

CAREL CPQ is the product selection and configuration tool designed to make the work of designers, customers and partners faster and simpler.

Benefits

- Low energy consumption;
- Wide capacity range, up to 1000 kg/h;
- Evaporative cooling effect;
- Products certified for compliance with hygiene requirements in accordance with VDI 6022-1.



humiFog multizone

UA*

Configurations

The humiFog system can be used in the following configurations:

Single-zone or multi-zone configuration

The humiFog single-zone configuration can be used to control humidity in an individual air handling unit.

In this configuration, modulation is implemented by managing the opening of different sets of nozzles and varying the water pressure in the range from 25 to 70 bars, using an inverter. This ensures perfectly calibrated and modulated humidity production based on the actual load.

humiFog is also a competitive adiabatic atomiser that is especially suitable for multi-zone and high capacity installations.

In the multi-zone configuration, it can supply up to 12 different distribution systems in different AHUs/rooms with just one pumping station (unique feature on the market!), each controlled based on its own humidity request.

Having just one pumping station significantly reduces installation and maintenance costs.

Configuration with distribution via duct or directly in the room

humiFog controls humidity by installing an atomised water distribution system inside an air handling unit or

alternatively directly in the controlled space.

Hygienic aspects

Certification in accordance with the most recent European standards (VDI6022) make humiFog for AHU suitable for all applications, even the most demanding in terms of hygiene, such as hospitals.

humiFog does not use chemical biocides, but only pure and simple water. The combination of humiFog with a reverse osmosis demineralisation and UV lamp disinfection system guarantees the highest level of feedwater hygiene.

humiFog does not atomise recirculated water: the built-in controller automatically fills the supply lines only when humidification is required. At the end of the humidification cycle, all of the lines are drained so as to prevent stagnation of water in the system. If there is no humidification demand for an extended period, the lines are automatically washed. All of the components of the distribution system in contact with water are made from AISI316 stainless steel.

Preheating probe on the rack

humiFog is the only humidifier on the market able to modulate its operating capacity based on the preheating temperature measured at the height of the rack distribution system. This

ensures high absorption efficiency even in transient operating conditions and in conditions where the optimum temperature has not been reached.

Feedwater specifications

For correct operation, the humiFog multizone system must be supplied with demineralised water (conductivity between 0 and 50 $\mu\text{S}/\text{cm}$). To obtain these values in the feedwater, a reverse osmosis system is typically required. This treatment involves pumping water through a special membrane that, being permeable only to molecules that are the same size as H_2O , removes almost all of the mineral salts in the water.

In addition to being a barrier that prevents the passage of bacteria, by eliminating mineral salts, reverse osmosis water treatment also reduces maintenance inside the AHU to simple periodic inspections!

Conductivity meter

The conductivity meter is used to monitor water quality and thus minimise maintenance. This achieves increased system hygiene, reliability and safety, as any problems are detected in the water treatment systems that supply the humidifiers.



Pulsation damper

The damper reduces the pressure peaks generated by the pump pistons so as to prevent them from being propagated along the pipes and distribution system.

7" touch display and configuration via USB flash drive

The new 7" touch display makes configuring and managing humiFog easy and intuitive. The display shows graphic maps of humidification system, from where the individual components can be controlled at a touch, making maintenance and troubleshooting much faster.

The humiFog Multizone Touch initial configuration parameters can also be downloaded directly from the Carel CPQ configuration tool, and then loaded onto the controller via the USB port, all guided by a step-by-step wizard. The configuration of even complex multizone systems can thus be completed from one single point of access in just a few minutes.



Certification

VDI

Carel has always paid the highest attention to the safety and hygiene of its proposed solutions: the humiFog range are thus also certified in compliance with the VDI regulations, now recognised as an international standard. The built-in controller automatically manages the washing, filling and emptying cycles, preventing the water from stagnating before being atomised into the humidified environment.



Silicone-free

The humiFog pump is also available in the silicone-free stainless steel version. The absence of silicone is essential in paint spray booths, to avoid the finish defect known as fisheye. Certification has been accredited by an external laboratory and is available on request.



ATEX

humiFog also responds to the need to guarantee a safe workplace for applications subject to ATEX classification. The distribution system is the result of careful analysis of design and materials, in full compliance with standards, eliminating sources or ignition from potentially explosive areas.



Components for installation in AHUs



Custom atomisation rack

(RH*)

The custom atomisation rack for AHUs comprises atomisation nozzles and shut-off valves, used to control the number of active racks, and drain valves for emptying the rack. All of the metal parts are made from stainless steel. The system can be supplied either partially assembled or completely assembled.



Wired solenoid valve option

A version of the atomisation rack is also available with the solenoid valves already wired, making connecting the rack to the zone controller extremely quick and easy.



ATEX installation option (potentially explosive atmospheres)

A version of the atomisation rack is available with the solenoid valves placed on a manifold positioned outside of the duct, in order to avoid the presence of electrical components inside the duct.



Certified droplet separator

(UAKDS*, ECDS10*)

The droplet separator has the purpose of capturing any droplets of water that have not completely evaporated and prevent them from leaving the humidification section. This is supplied as easy-to-assemble modular panels to cover the entire cross-section of the AHU.

It is available in two versions: with fibreglass or steel filter mesh, the latter required for VDI6022 certified installations.



Zone panel

Manages the distribution system in an individual AHU. Multiple panels (up to 12) can be connected to control several AHUs with one single humiFog pumping station.

Example of operation with direct and indirect evaporative cooling

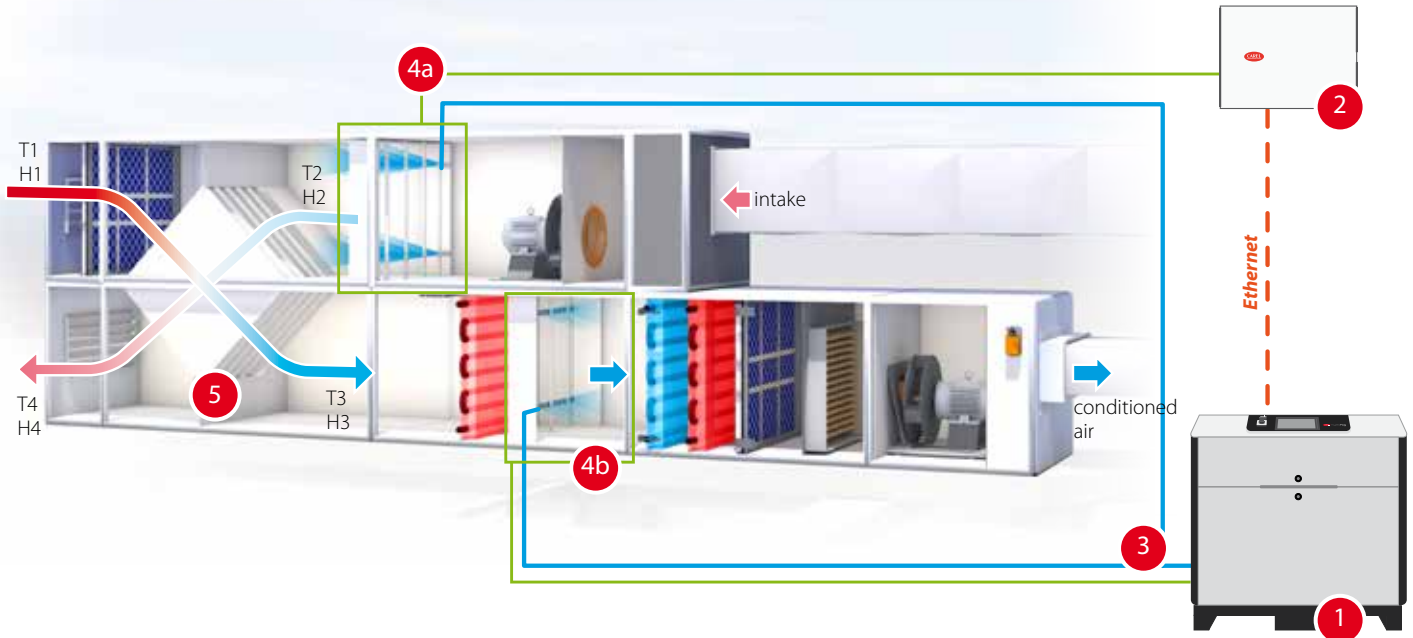

Winter/summer operation

The winter/summer function allows air humidification in winter, while in summer humiFog is used to evaporatively cool the inlet air.

Direct evaporative cooling

This extends the range in which free cooling can be used, by evaporatively cooling the inlet air, while always controlling the relative humidity set point (4b).

Indirect evaporative cooling

This is applied to the exhaust air, which can be cooled by several degrees without limits in terms of humidity (the air is discharged by the AHU), by flowing

first through a cross-flow heat exchanger together with the inlet air. This pre-cools the fresh air, reducing the capacity required by mechanical cooling (chiller) to bring the air to the desired conditions, thus reducing power consumption. The efficiency of this solution depends on the heat recovery unit used and the outside climatic conditions, yet easily exceeds 50% (see the example below). The humiFog multizone is perfect for these types of applications in AHUs.

- 1 pumping station and controller zone for humidification in winter and direct evaporative cooling
- 2 zone controller for indirect evaporative cooling
- 3 pressurised water line
- 4 a: rack for indirect evaporative cooling
b: rack for direct evaporative cooling
- 5 heat recovery unit
- 6 droplet separator

	Outside air		Exhaust air		Cooled outside air		Outlet air		Cooling capacity*
	T ₁	H ₁	T ₂	H ₂	T ₃	H ₃	T ₄	H ₄	P
WITHOUT evaporative cooling	35 °C	40% RH	25 °C	50% RH	29 °C	56% RH	31 °C	36% RH	58 kW
WITH evaporative cooling	35 °C	40% RH	18 °C	saturation	25 °C	70% RH	28 °C	55% RH	100 kW
							Additional capacity		42 kW

In the example shown in the table, the exhaust air is pre-cooled to 18 °C and then used by the heat exchanger to cool the outside air from 35 to 25°C, a decrease of 10 °C, without increasing absolute humidity.

*: The cooling capacity is calculated based on an outside air flow-rate of 30000 m3/h, atomising 100 kg/h of water, and a heat recovery unit with an efficiency of 58%.

humiFog multizone Touch table

Specifications	UA1501D5**	UA3001D5**	UA5001D5**	UA8001L5**	UA1K21L5**
Installation conditions					
Ambient temperature	5T40 °C (41T104 °F)				
Ambient relative humidity	0-90% rH				
Water circuit data					
Flow-rate (kg/h) (gal/d)	150 (951)	300 (1902)	500 (3170)	800 (5072)	1200 (7608)
Feedwater conductivity (µS/cm)	< 50				
Feedwater pressure (bars) (PSI)	2 to 5 (40 to 100)				
Feedwater temperature (°C) (°F)	5 to 40 (41 to 104)				
Water inlet connections to the cabinet	G3/4"F				
Water connections from the cabinet to the rack	M16x1.5 M			M22x1.5 M	
Water drain connections	G1/4"F				
Physical specifications					
Weight (kg) (lb)	94 (207)	95 (209)	105 (231)	117 (258)	116 (256)
Dimensions mm (inch)	width: 850 (33); depth: 480 (19); height: 945 (37)				
Clearance required (mm) (inch): top - sides - front	500 (20) - 500 (20) - 1000 (40)				
Ingress protection (IP)	IP20				
Electrical specifications					
Voltage (Vac)	230 (±10%)			400 (±10%)	
Electrical phases	1			3	
Frequency (Hz)	50/60 (±1%)				
Power consumption (kW)	0,65	1,25	1,65	3,35	4,35
Current (A)	4,8	7,4	10	3,9	4,9

Zone control panel

Specifications	UA000SD500	UA000S2500	UA000SU500
Installation conditions			
Ambient temperature	5T40 °C (41T104 °F)		
Ambient relative humidity (rH)	0-90% rH		
Physical specifications			
Weight (kg) (lb)	19,6 [43]		
Dimensions mm (inch)	width: 491 (19.3); depth: 155 (6.1); height: 433 (17)		
Clearance required (mm) (inch): top - sides - front	500 (20) - 500 (20) - 1000 (40)		
Ingress protection (IP)	IP20		
Electrical specifications			
Voltage (Vac)	230 (±10%)		208 (±10%)
Electrical phases	1		
Frequency (Hz)	50 (±1%)	60 (±1%)	60 (±1%)
Power consumption (kW)	0,5		
Current (A)	2,2		2,5

Dimensions in mm (in) and weights in kg (lb)



Mod.	AxBxC	weight	LxWxH	weight
UA main cabinet	850 x 480 x 945 (33.5 x 18.9 x 37.3)	94 to 116 (206.8 to 255.2)	975 x 620 x 1135 (38.5 x 24.5 x 44.7)	104 to 126 (228.8 to 277.2)
UA zone control	491 x 155 x 433 (19.4 x 6.1 x 17.1)	19.6 (43.2)		22,2 (43.2)

Part number

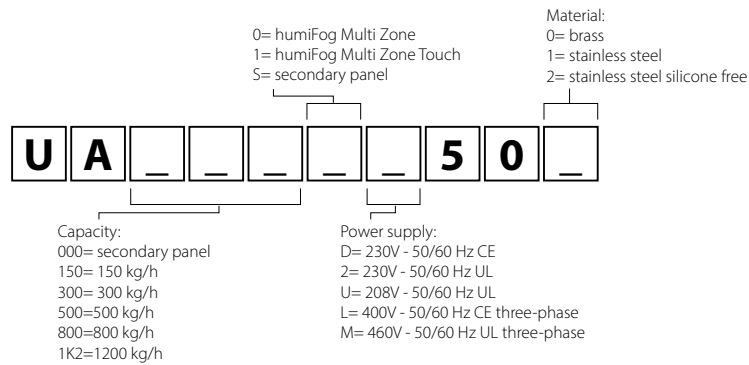

Overview humiFog multizone

duct applications

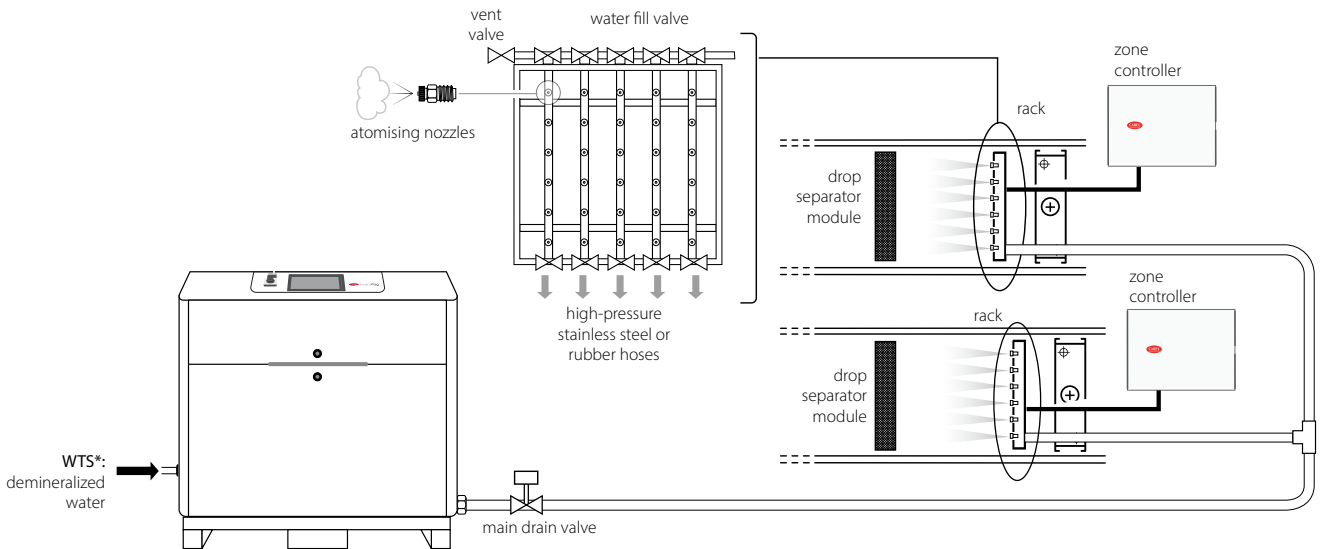



optiMist

EC**

optiMist is a humidifier and evaporative cooler that uses a vane pump to pressurise the water and subsequently atomise it through special nozzles.

optiMist is a complete system, which in one solution provides both humidification and evaporative cooling and which can be used in an AHU (air handling unit) to both humidify the supply air (direct evaporative cooling) and indirectly cool the return air, for example using a cross-flow heat recovery unit.

System components

- **pumping station** that pressurises the water (from 4 to 15 bars): this also contains the electronic controller that completely manages the pumping station, controlling the temperature/humidity in each optiMist section. The sophisticated control system combines the action of an inverter, which controls the speed of the pump and therefore the flow-rate, with two solenoid valves that activate only the nozzles that are needed. This means that the system always works at the optimum water atomisation pressure;
- **distribution system**: this comprises stainless steel pipes, compression fittings, atomising nozzles and drain valves (stand-alone mechanical valves or solenoid valves managed by the controller). optiMist can be used with a two-circuit modulating distribution system to increase the precision of temperature or humidity control. When combined with two distribution

systems, it becomes an integrated solution for the management of both humidification and indirect evaporative cooling (with just one pumping station and without additional electrical panels);

- **droplet separator**: needed to avoid wetting the humidification or evaporative cooling sections. The drainage structure simplifies droplet separator maintenance, as the filter modules can be removed from the front without the need to disassemble the structure.

Hygiene

All CAREL spray humidifiers are designed in accordance with the guidelines of the VDI6022 standard. In particular, for products that provide evaporative cooling, the sophisticated electronic system that manages the distribution line drain solenoid valves prevents stagnation of water in the pipes, one of the main risks for the proliferation of bacteria.

In addition, the distribution lines are automatically washed at set time intervals. The UV lamp option guarantees further disinfection of the incoming water, while further treatments are available to improve the hygiene of the feedwater.

Feedwater

Following the evaporation process, the mineral salts dissolved in the feedwater will partially accumulate in the nozzles, on the droplet separator and on the inside surfaces of the AHU in general.

The nature and quantity of mineral salts contained in the water determine how frequently routine maintenance will be needed to remove these deposits from inside the AHU. To maintain system hygiene and reduce system running costs, CAREL recommends using demineralised water from reverse osmosis to supply optiMist, as required by the main standards (UNI 8884), which define the feedwater characteristics as:

- conductivity <100 µS/cm;
- total hardness <5 °fH (50 ppm CaCO₃);
- 6.5 <pH < 8.5;
- chloride content <20 mg/l;
- silica content <5 mg/l.

If demineralised water is not available, softened water can be used. In this case, to limit aggressiveness, it is recommended to guarantee a minimum hardness of no less than 3 °fH. The use of mains water will require more frequent routine maintenance operations (cleaning or replacement of the nozzles and the droplet separator), depending on the chemical composition of the water.

Accessories



Drain valve (ECKD*)

This is installed in the distribution system drain circuit to ensure complete emptying. These valves can be used to set periodic washing cycles, very important for guaranteeing system hygiene. Depending on the needs of the application, either the ECKDSV0000 solenoid valves, electrically controlled by the optiMist cabinet, or the ECKDMV0000 mechanical valves that open and close according to operating pressure, can be used.



Droplet separator for AHU/duct (UAKDS*, ECDS*)

The droplet separator is designed to capture any water droplets that have not completely evaporated, so as to prevent them from leaving the humidification/cooling section. This is supplied as easy-to-assemble modular panels to cover the entire cross-section of the AHU.

The droplet separator has very low pressure drop, just 30 Pa with an air speed of 3.0 m/s. The separator support structure is always made from stainless steel and guarantees quick and efficient drainage of the water.

The droplet separator can be supplied with fibreglass or stainless steel modules, depending on the requirements of the application.

optiMist table

Specifications	EC005*	EC010*	EC020*	EC040*	EC080*	EC100*
General						
Power supply	EC*0= 230 V, 1 phase, 50 Hz EC*U= 230 V, 1 phase, 60 Hz					
Power consumption (at 50 Hz)	0.275 kW	0.275 kW	0.475 kW	0.475 kW	0.75 kW	
Current draw	1.2 A	1.5 A	1.6 A	2.3 A	3.0 A	3.2 A
Operating conditions - °C (°F)	5 - 40 (34 - 104) <80% rH non-condensing					
Water fill						
maximum flow-rate	50	100	200	400	800	1000
inlet pressure - MPa; bars; psi	0.2 - 0.7; 2 - 7; 29 - 100					
connections	EC*0= G3/4" F EC*U= NPT 3/4" F					
Water drain						
connection	stainless steel pipe coupling, ID G3/4" F, OD ~ 35 mm/1.18 inch.					

Dimensions in mm (in) and weights in kg (lb)



Model	AxBxC	weight	LxWxH	weight
EC005*, EC010*	630x300x800 (24.8x11.82x31.5)	53 (117)	720x410x1020 (28.36x16.14x40.16)	56 (124)
EC020*, EC040*	630x300x800 (24.8x11.82x31.5)	55 (121)	720x410x1020 (28.36x16.14x40.16)	58 (128)
EC080*, EC100*	630x300x800 (24.8x11.82x31.5)	59 (130)	720x410x1020 (28.36x16.14x40.16)	62 (137)

Part number

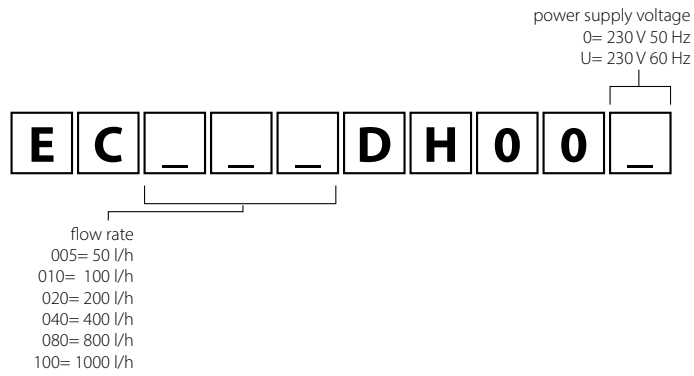

Overview optimist

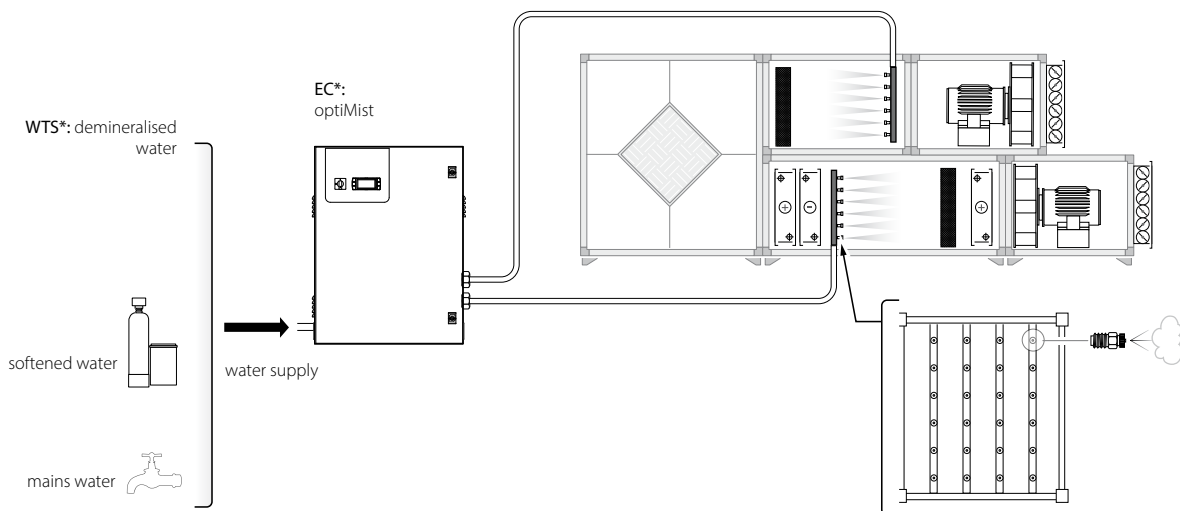



humiSonic ventilation

UU*

The humiSonic version for air handling units makes adiabatic humidification available even in small ducts. Installed directly in the air flow, humiSonic atomises water into very fine droplets (1 µm), which are instantly absorbed by the air.

Hygiene

This new generation of ultrasonic humidifiers incorporates all of CAREL's experience in guaranteeing the highest hygiene: all of the components in contact with demineralised water are made from stainless steel, while the main body is designed to prevent water stagnation at the end of the humidification cycle. Moreover, the electronic controller manages periodic washing cycles when the system is off.

High efficiency

humiSonic, with an energy consumption of less than 80 W per litre of atomised water, is the best choice for applications where the priority is energy saving. Furthermore, the minute size of the droplets, measuring around 1 µm, mean the atomised water is completely absorbed by the air flow in just 50-60 cm.

Easy installation and maintenance;

humiSonic for air handling units comprises two parts: the main body (containing the piezoelectric transducers) and the electrical power and control panel.

The main body can easily be positioned inside the air handling unit, while the electrical panel can be installed outside of the humidification section.



Electrical panel

UQ*

Ultrasonic humidifiers, installed inside the air handling units, are powered and controlled by an electrical panel, complete with display.

Dimensions in mm (in) and weights in kg (lb)

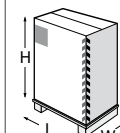
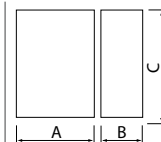

Mod.	AxBxC	weight	LxWxH	weight
UU02D*	275x256x309 (10.8x10.1x12.2)	4.9 (10.8)	510x410x410 (20.07x16.14x16.14)	5.9 (13)
UU05D*	400x256x309 (15.7x10.1x12.2)	6.4 (14.1)	640x410x410 (25.20x16.14x16.14)	7.4 (16.3)
UU07D*	525x256x309 (20.7x10.1x12.2)	8 (17.6)	760x410x410 (29.92x16.14x16.14)	9.5 (20.9)
UU09D*	650x256x309 (25.6x10.1x12.2)	9.5 (20.9)	890x410x410 (35.04x16.14x16.14)	11 (24.2)
UU14D*	900x256x309 (35.4x10.1x12.2)	12.7 (28)	1150x410x410 (45.27x16.14x16.14)	14.7 (32.4)
UU18D*	1150x256x309 (45.3x10.1x12.2)	15.8 (34.8)	1350x410x410 (53.15x16.14x16.14)	17.8 (39.2)

humiSonic ventilation table

Specifications	UU02D*	UU05D*	UU07D*	UU09D*	UU14D*	UU18D*
Atomised water production - kg/h (lb/h)	2.4 (5.3)	4.8 (10.5)	7.2 (16)	9.6 (21)	14 (31)	18 (39.6)
Atomised water outlet - Ø mm	Ø= 40 mm					
Feedwater inlet - mm	OD= 8 mm (5/6", ID= 6 mm (15/64"))					
Feedwater temperature - °C (°F)	1 - 40 °C - 33.8 - 104 °F					
Feedwater pressure - bars (psi)	0.1 - 6 bars (14.5 - 87 psi)					
Fill flow-rate - l/min	0.6 l/min					
Feedwater - µS/cm	0-80 µS/cm					
Water drain connection - mm	OD= 8 mm (5/6", ID= 6 mm (15/64"))					
Max drain flow-rate - l/min	1.9 l/min					
Power - W	210	350	500	650	950	1150
Power supply	230 V, 50/60 Hz; 110 V, 50/60 Hz					
Current draw - A	0.7/1.5	1.3/2.7	2.0/4.0	2.6/5.5	4.0/8.2	4.7/10
Power cable size- mm2	0.823 mm2					
Control signals						
Enable ON/OFF	●	●	●	●	●	●
RS485 serial (CAREL or Modbus® protocol)	●	●	●	●	●	●
Signal from active probe - V	0 - 10, 0 - 5					
External control signals - V						

● standard

Part number

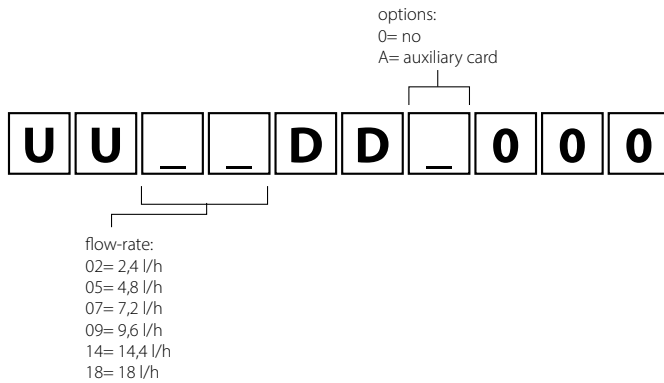

Overview humiSonic

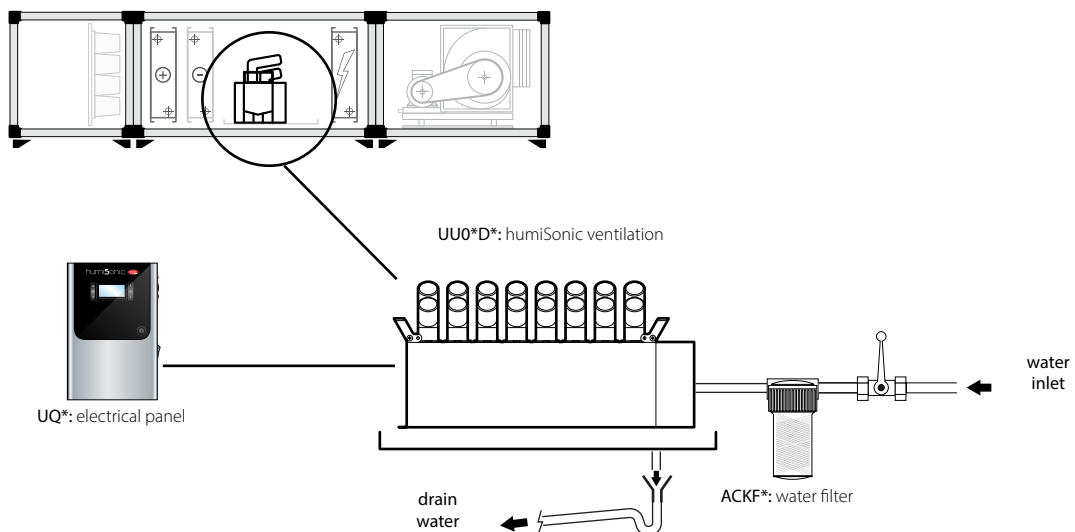



Heat recovery units

European regulation (EU) no. 1253/2014, which implements the EU directive with regard to ecodesign requirements for ventilation units, has made it mandatory for non-residential air handling units to be equipped with a heat recovery system. Following the acquisition of Recuperator, world leaders in the production of static plate and rotary heat recovery units, CAREL can now offer a complete range with the best solutions in terms of performance and energy efficiency.



Plate heat exchangers

Intake of fresh outside air is essential to ensure the right indoor air quality. The temperature of the outside air however needs to be controlled before it is delivered into the rooms.

This means an increase in energy consumption, which can however be reduced using a heat recovery system. These systems recover a considerable part of the heat contained in the exhaust air stream, and transfer it to the fresh air intake, allowing significant savings in the running of air conditioning systems. Plate heat exchangers transfer heat between two air streams due to the temperature difference. These heat exchangers are designed to transfer energy from one air stream to another, without any moving parts.

They comprise a series of thin parallel plates that separate the air intake and exhaust streams.

Benefits

- Low installation and operating costs
- Complete separation of air streams
- Low pressure drop
- Minimum maintenance
- High efficiency
- Adaptable to any application



A + B series

A*, B*

Cross-flow plate heat recovery units designed for air flow-rates up to 80,000 m³/h and efficiency in compliance with the European Ecodesign directive 2018.

Main benefits

- High-efficiency layout
- Wide range of sizes
- Easy to clean
- Low leakage (SC option as standard)
- Lightweight frame for compact installation
- Sections made from aluminium and aluminium with epoxy protection. Side panels made from galvanised steel, aluminium, and galvanised steel with epoxy protection.

Specifications

- Flow-rate up to 80,000 m³/h
- High efficiency, up to 80%
- Low pressure drop, recommended ΔP 200 Pa
- Maximum differential pressure supported up to 2000 Pa (extra option up to 2500 Pa)
- Maximum operating temperature up to 90 °C (no silicone), option up to 200 °C

Structure

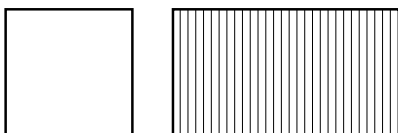

Fins for A series



B-Blue

Gold

Aluminum

Fins for B series

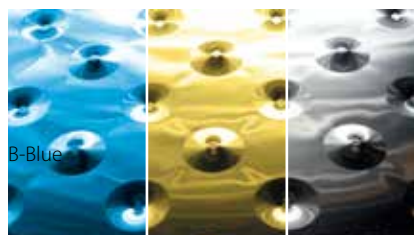

B-Blue

B-Blue

Gold

Aluminum



E Series

E*

Main benefits

- Very high efficiency in a compact space
- One piece only for high flow rates
- New type of damper
- Sections made from aluminium and aluminium with epoxy protection. Side panels made from galvanised steel, aluminium, and galvanised steel with epoxy protection.

Specifications

- Flow-rate up to 10,000 m³/h
- High efficiency, up to 80%
- Low pressure drop, recommended ΔP 200 Pa
- Maximum differential pressure supported up to 2000 Pa
- Maximum operating temperature up to 90 °C (no silicone)

Structure

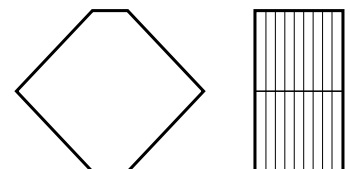



Configuration

EXSTREAM The Cross-Counterflow

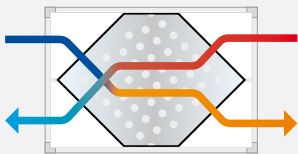

EXSTREAM is the cross-counterflow technology by Recuperator. The large counterflow area, the hexagonal shape and the fin arrangement guarantee even higher high efficiency and low pressure drop. Even in the most extreme applications.

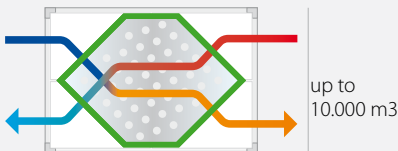

- No combi
- Single module



- Maximum tightness between flows
- High quality

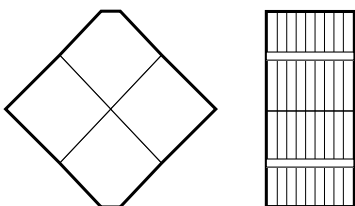

F Series

F*

Cross-flow plate heat recovery unit designed for air flow-rates of up to 100,000 m³/h and efficiencies compliant with the EU Ecodesign directive of 2018

Main benefits

- High efficiency
- Low pressure drop
- Withstands high pressure differences
- Capable of handling high volumes of air
- Sections made from aluminium and aluminium with epoxy protection. Side panels made from galvanised steel, aluminium, and galvanised steel with epoxy protection.

Specifications

- Flow-rate up to 20,000 m³/h
- High efficiency, up to 80%
- Low pressure drop, recommended ΔP 200 Pa
- Maximum differential pressure supported up to 2000 Pa
- Maximum operating temperature up to 90 °C (no silicone)

Fins for F series

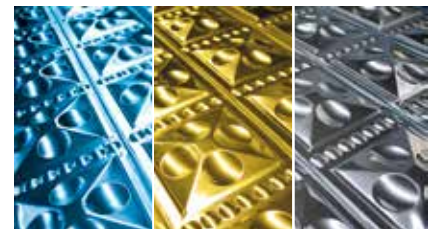

B-Blue

Gold

Aluminum

Structure

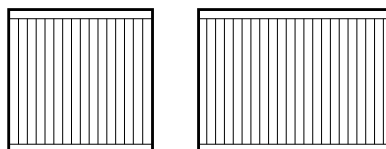

Fin materials

Aluminium

Aluminium is used in almost all applications, being resistant to corrosion, easy to machine, non-flammable and durable.



SILVER fin example

Aluminium with epoxy protection (GOLD)

In environments with aggressive atmospheres, it is recommended to protect the aluminium with non-toxic protective epoxy paints.



GOLD fin example

Aluminium with hydrophilic protection and adsorbent (BBLUE)

RECUPERATOR has developed a new hydrophilic protective coating for the aluminium fins, which improves system efficiency and ensures high corrosion resistance.

This new solution is ideal for integrating an indirect evaporative cooling system into the air handling unit.

Available for all A, B, E, and F series



Options

Bypass options

- Bypass section only;
- Side bypass;
- Centre bypass;
- Aluminium dampers and dampers with protective coating;
- Dampers without plastic parts;
- Damper with external control;
- Damper with internal control;
- Recirculation damper
- Wide range of damper shaft positions;
- Round or square shafts;
- 12 mm or 16 mm shafts.



Bypass section only



Centre bypass with damper

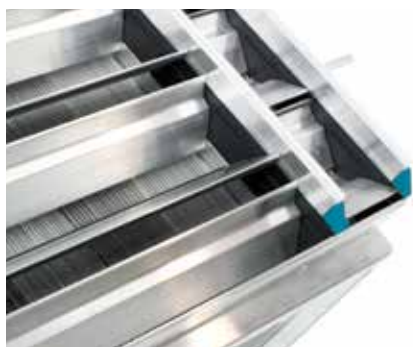

Side bypass with damper

Hygienic applications

Recuperator has always been attentive to health and safety. Its recuperators are tested and certified in compliance with international hygiene standards (VDI 6022, VDI 6022 Blatt 1, SWKI VA104-01, ÖNORM H 6021 etc.).

Options for hygienic applications ensure material safety, minimal contamination between flows and high resistance to differential pressures.

Certifications

Recuperator has always been concerned about the quality of its products. Over the years it has led to the achievement of several certifications by the main international institutes.





RECUPERATOR
THE HEAT EXCHANGER



Air is our element
KLINGENBURG
energy recovery our passion

Rotary heat exchangers

Save energy in offices, factories, at home or on cruise ships, and in many other applications.

Rotary heat exchangers work perfectly whatever the diameter: from half a metre up to eight metres. Rotary heat exchangers are the most efficient heat recovery system, regardless of the application. When handling high air flow-rates, no other system can match their performance.

Our thermal wheels can reach efficiencies of over 85%. This means considerable energy savings and

therefore lower costs.

All for different applications:

- Classic HVAC technology (e.g. office buildings, industrial buildings, apartments, marine applications);
- Process industry (e.g. chemicals, pharmaceuticals, food);
- High temperature applications (e.g. brick firing, power plant technology);
- Surface coating technology (e.g. automotive painting);
- Data centre cooling (e.g. KyotoCooling);
- Active drying applications (e.g. chemicals, pharmaceuticals, food);
- Dehumidification.

Benefits

- High performance;
- Very high efficiency;
- Compact dimensions;
- Low pressure drop

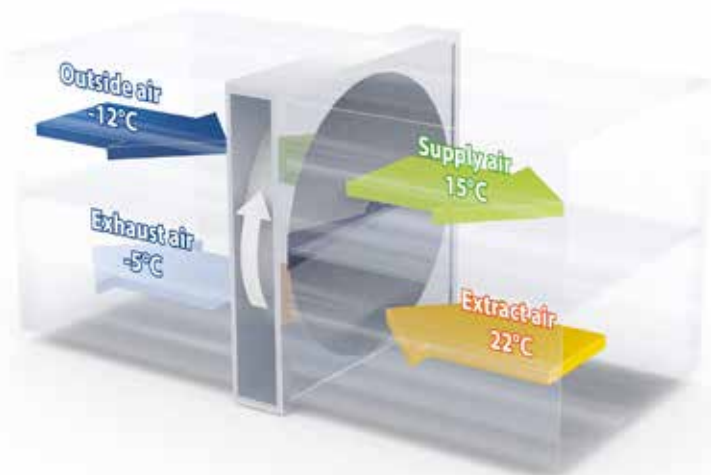

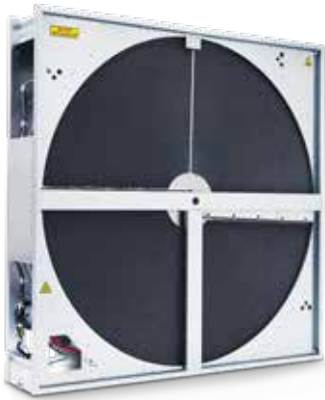

RRU ECO

Guarantees higher capacity and lower pressure drop for the same cross-sectional area.

Main benefits

- When housing sizes between 600 and 2,550 mm, the difference between the storage mass and the housing is just 50 mm, even with a minimum installation depth of only 290 mm.
- Galvanised steel, AlZn or Magnelis housing
- Adjustable gasket system
- Purge section available in two sizes (2.5 or 5 °)

Technical specifications

Housing material: galvanised steel, AlZn or Magnelis frame

Non-split casing construction up to: Ø 2,500 mm storage mass

Split casing version: no

Guide with inspection openings on the narrow side: yes

Inspection openings through triple doors upstream and downstream: optional for models larger than 1251 mm

Seals: high quality brush seals

MicroMax controller for gear drive: up to 2,550mm in size

DRHX controller drive package with Modbus and stepper motor:

- up to 1,950 mm (N) in size
- up to 2,550 mm (P/E/K) in size.

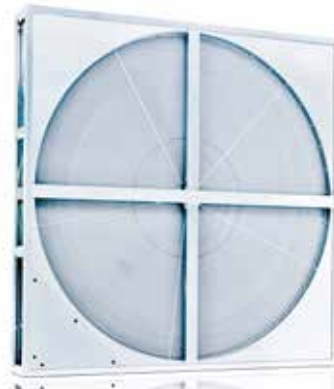

RRS

Suitable for both vertical and horizontal installation.

Main benefits

- Galvanised steel or AlZn housing;
- for vertical and horizontal installation
- Variable housing dimensions up to a maximum of 4,250 mm (H x W)
- Starting from wheels with a diameter of 2,380 mm in the split design; optional special division for smaller sizes

Technical specifications

Housing material: galvanised steel or AlZn frame

Maximum size: 4250 x 4250 mm

Non-split casing construction up to: storage mass Ø 2,381 mm

Split casing version: from Ø 2,381 mm (smaller sizes on request)

Guide with inspection openings on the narrow side: yes

Inspection openings through triple doors upstream and downstream: optional starting from 1,500 mm

Seals:

- Pressure-resistant felt gasket,
- Special plastic gasket: Murtfeld for storage mass Ø 1,650 mm.



RRT

Designed with salt water resistant aluminium alloy housing and welded aluminium frame.

Main benefits

- welded aluminium frame
- for vertical and horizontal installation
- Salt water resistant aluminium alloy housing and casing
- Variable housing dimensions up to a maximum of 8000 mm (H x W)

Technical specifications

Housing material: salt water resistant aluminium alloy

Non-split casing construction up to: storage mass diameter < 3,000 mm

Split casing version: starting from storage mass diameter > 2,381 mm

Guide with inspection openings on the narrow side: yes

Inspection openings through triple doors upstream and downstream: optional starting from 1,500 mm

Seals:

- Pressure-resistant felt seals,
- Special plastic seals: Murtfeld starting from storage mass Ø 1,650 mm



RRV

Designed with stainless steel housing for the most demanding applications. Available with all types of storage mass.

Main benefits

- welded stainless steel housing;
- for vertical and horizontal installation
- Variable housing dimensions up to a maximum of 4,250 mm (H x W)
- Starting from wheels with a diameter of 2,380 mm in the split design; optional special division for smaller sizes

Technical specifications

Housing material: Stainless steel: V2A or V4A

Maximum size: 4250 x 4250

Non-split casing construction up to: storage mass starting from Ø 2,381 mm

Version with split casing: storage mass starting from Ø 2,381 mm

Guide with inspection openings on the narrow side: yes

Inspection openings through triple doors upstream and downstream: optional starting from 1,500 mm

Seals:

- Pressure-resistant felt seals.

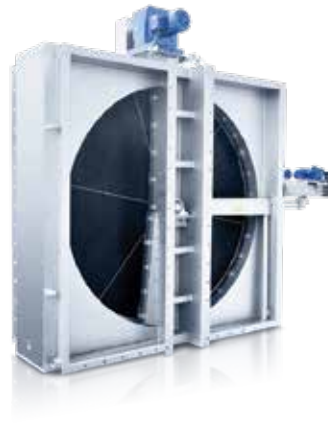

EM (up to 300°C)

Designed for high air temperature applications. The materials and components have been chosen to withstand extreme working conditions and corrosion.

Technical specifications

Housing:

- steel or stainless steel
- Robust construction with welded double-walled U-section and thermal insulation
- Material: S235JR + AR
- Temperature:
 - EM: up to 300 °C
 - EH: up to 600 °C

Type of storage mass: Corrugated rotor mass with integrated, welded stainless steel spoke structure. The wide cross-section and constantly changing air flow direction through the rotor ensures self-cleaning.

Material:

- 1.4301, 1.4571 or 1.4539 stainless steel
- 0.1 mm thick

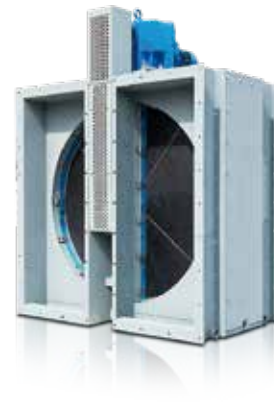

EH (up to 600°C)

Types of storage mass

Type P

Condensation, aluminium storage mass (standard)

Type K

Storage mass with epoxy coating
(corrosion protection)

Type E

Zeolite/aluminium hybrid storage mass (increased moisture transfer)

Type N

Zeolite-coated storage mass
(maximum moisture transfer)

For mod. EM, EH

Corrugated rotor mass with integrated, welded stainless steel spoke structure. The wide cross-section and constantly changing air flow direction through the rotor ensures self-cleaning.

Wave heights

RRU, RRS, RRV, RRT: 1,4, 1,6, 1,8, 2,0, 2,2, 2,4 mm

EM, EH:

- 2.1 mm for applications with medium levels of exhaust air pollution.
- 3.0 mm for applications with high level of exhaust air pollution.

Table of technical specifications

	RRU ECO	RRS	RRV	RRT
Maximum dimensions (mm)	2,550x2,550	4,250x4,250	4,250x4,250	8,000x8,000
Standard depth (mm)	290/330	<ul style="list-style-type: none"> • 400 mm up to 2,000 mm housings • 440 mm up to 3,000 mm housings • 550 mm up to 4,250 mm housings 	<ul style="list-style-type: none"> • 400 mm up to 2,000 mm housings • 440 mm up to 3,000 mm housings • 550 mm up to 4,250 mm housings 	<ul style="list-style-type: none"> • 400 mm up to 2,000 mm housings • 440 mm up to 3,000 mm housings • 510 mm up to 4,000 mm housings • 550 mm up to 5,000 mm housings • 650 mm up to 8,000 mm housings
Installation position	vertical	horizontal/vertical	horizontal/vertical	horizontal/vertical
MicroMax controller for gear drive	up to 2,550 mm in size	up to 4250 mm in size	up to 4250 mm in size	up to 8000 mm in size
DRHX controller drive package with Modbus and stepper motor:	<ul style="list-style-type: none"> • up to 1,950 mm (N) in size • up to 2,550 mm (P/E/K) in size 	<ul style="list-style-type: none"> • up to 2060mm (N) in size • up to 2660 mm (P/E/K) in size 	<ul style="list-style-type: none"> • up to 2060mm (N) in size • up to 2660 mm (P/E/K) in size 	<ul style="list-style-type: none"> • up to 2060mm (N) in size • up to 2660 mm (P/E/K) in size

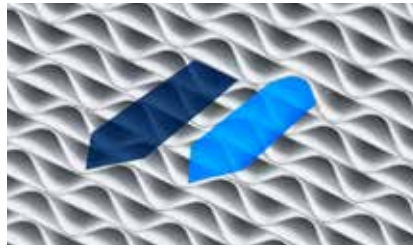

Detailed view of storage masses

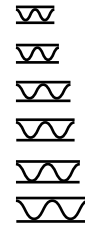

Storage mass wave heights

Storage mass

Rotary heat exchangers resemble a wheel, which is why they are also called thermal wheels or rotors. Made from aluminium foil, these wheels comprise a vast number of small channels for air two flow through and transfer heat to the storage mass. Aluminium is ideal for this purpose, due to its high thermal conductivity.

How the storage mass works

The thermal wheel rotates between separate air flows: the supply air, which carries outside air into the building, and the exhaust air, which carries the "spent" indoor air back outside. The fresh outside air flows through one half of the storage mass, while the exhaust air flows through the other half. In this process, most of the heat from the exhaust air is transferred to the storage mass. This heated half of the wheel continues rotating until coming into contact the cooler supply air, thus giving off heat. Klingenburg offers different types of storage masses and wave heights. The aluminium sheet is between 0.07 and 0.1 mm thick, while the wave heights are between 1.4 and 2.4 mm. The thickness and wave heights used vary according to the level of dust and contamination in the air that flows through the mass.



Condensation

Wheel with corrosion-resistant aluminium alloy foil, mainly for heat exchange. Moisture recovery only if the exhaust air temperature falls below the dew point.

Preferred application

Systems without humidification and without cooling.



Hybrid (enthalpy)

Wheel with foil made from alternating layers of aluminium alloy and coated with zeolite. Provides greater moisture transfer than the condensation versions by exploiting the potential difference between the outside air and exhaust air, as well as the classic condensation effect.

Preferred application

Systems with humidification and without cooling.



Absorption

In HUGO models with DekaTru® coating technology. Highly hygroscopic zeolite coating that maximises heat and moisture transfer throughout the year. For example, in hot areas with high humidity, these wheels save huge amounts of costly energy for cooling.

Preferred application

Systems with humidification and cooling, lower cooling capacity by drying and cooling the outside air.

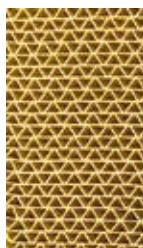

Epoxy resin

Storage mass made from aluminium foil coated in epoxy resin for high corrosion protection. Suitable for environments with aggressive or corrosive air, such as swimming pools, paint shops, animal stables, battery depots or industrial extraction systems.

Preferred application

Systems with high exhaust air requirements, such as: swimming pools, industrial exhaust systems, exhaust air from adiabatic humidification, paint spray booths, adiabatic cooling.



R Series

R*

The R series thermal wheels recover energy, in terms of both heat and humidity, from the exhaust air and transfer it to the supply air.

Main benefits:

- Wide range of sizes;
- High efficiency, up to 80%;
- Possibility to recover both heat and humidity;
- Low pressure drop, recommended 150 Pa.

Specifications:

- Air flow-rates up to 100,000 m³/h;
- Segmented structure and frame with diameter up to 4200 mm.

Wheel treatment

All wheels have an aluminium matrix.

Standard aluminium "AL"

The rotary condenser allows moisture to be transferred when, in winter conditions, the exhaust air flow falls below dew point. This is the most cost-effective solution for recovering heat in most applications.



Sorption (AR, AZ)

The silica gel adsorbent treatment (AR) that covers the aluminium matrix ensures recovery of both sensible and latent heat, reaching very high efficiency values, and consequently guaranteeing considerable energy savings. Also available in the high-performance version with 3Å (AZ) molecular-based hygroscopic coating.



Hybrid (AT)

The hybrid enthalpy wheel recovers both latent and sensible heat, thanks to the hygroscopic matrix that allows exchanges humidity between the exhaust stream and the fresh air inlet.

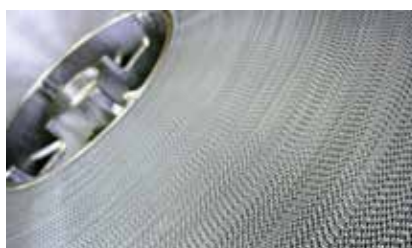

Epoxy corrosion protection (AC)

In environments with aggressive atmospheres, aluminium protected by a non-toxic, corrosion-resistant epoxy coating (AC - Gold version) is recommended).



Structure

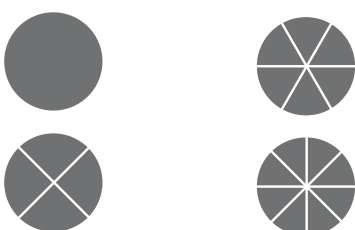

A close-up photograph of a damper handle and hinge mechanism on an air handling unit. The handle is a dark, curved metal piece, and the hinge is a white plastic component. The background shows the internal structure of the unit with horizontal louvers.

Dampers and accessories

The quality and efficiency of an air handling unit depends on the quality of its air-flow components, such as dampers, handles and other accessories. Enginia, a CAREL Group company, is a leader in the air engineering sector. It designs and manufactures products with innovative technology specifically for air handling units, with the focus on solutions aimed at increasing AHU energy efficiency. Dampers, louvers, handles and hinges are part of a vast range of products that meet every need. The possibility of developing co-engineering solutions makes CAREL the ideal partner for building better air handling units.



Dampers and accessories

Balancing energy consumption and the need for healthy environments, air handling units have become the heart of ventilation systems. Consequently, every individual component must guarantee higher quality standards and the utmost air-tightness. The design of our components guarantees high performance and better air quality inside offices, entertainment venues and production plants.

Ensuring the correct control of air flows for balanced air conditioning systems requires the use of suitable dampers, based on the application. This also helps improve the efficiency of the air handling unit.

Choosing handles and hinges that prevent air leaks and ensure perfect closure is essential for ventilation system efficiency.

Finally, compliance with the highest quality and safety standards is the best guarantee for manufacturers of air handling units.

Enginia is the ideal partner for achieving these crucial objectives. Enginia is the CAREL Group company operating in the air-flow sector.

Calibration dampers, louvers and droplet eliminators. Plastic components for AHUs, corners and U-joints for

aluminium frames, handles, hinges, and inspection portholes, as well as the development of co-engineered products are the cutting-edge solutions the company supplies to meet the needs of air handling unit manufacturers.

Benefits

- High quality components;
- Certification for ATEX explosive environments;
- Co-engineering;
- High efficacy;
- Adaptable to any application.



Dampers

A*, B*

Enginia offers a wide range of dampers: different tightness classes in accordance with EN 1751, different materials (galvanised, aluminium and stainless steel), also available with painted,

anodised. The range includes blades in different heights, 50/100/150/200 mm, to meet every need. Dampers are available for specific applications: hygiene, ATEX, thermal break and

overpressure dampers.

Main benefits

- Wide range of shapes and sizes.

50 mm step		100 mm step		150 mm step		200 mm step	
Leakage class (tightness)	Description	Leakage class (tightness)	Description	Leakage class (tightness)	Description	Leakage class (tightness)	Description
Galvanised steel							
2, 4	with gears / bypass dampers	0, 2, 4	with gears	3, 4	industrial	3, 4	industrial
		0, 2, 4	with linkages	3, 4	with linkages	3, 4	with linkages
			with gears or linkages, bypass damper				
		2, 4	with linkages, ATEX				
		2, 4	with linkages, insulated				
Aluminium							
---	---	0, 2, 4	with gears				
		0, 2, 4	with linkages	3, 4	with linkages		
			with linkages, ATEX				
		2, 4	with linkages, insulated				
Extruded aluminium							
2	with gears / bypass damper	2	with gears				
		2, 4	with gears + 115 frame				
		2	with gears, bypass damper				
		4	with gears, thermal break				
Stainless steel							
2, 4	stainless steel frame, extruded aluminium blades with gears/ bypass damper	2, 4	extruded aluminium blades steel linkages	3, 4	steel blades, steel linkages, ATEX industrial series	3, 4	steel blades, steel linkages ATEX industrial series



Hinges

CFG*

Enginia offers a series of fixed and adjustable hinges for perfectly fixing the doors on air handling units.

Main benefits

- quick and easy installation;
- perfect compression of the gasket;
- weather resistance.

Technical specifications

- Fixed or adjustable (up to 3 directions);
- 180° opening;
- Screw covers to reduce oxidation, with an attractive design (570 series);
- Materials: plastic, aluminium and zamak.



Dual series

DUAL

The innovative principle of the DUAL hinges allows the doors to be opened either to the right or to the left, as well as be completely removed, thus facilitating the work of maintenance personnel, even in confined spaces. The use of four identical elements replaces the concept of using different elements, i.e. hinges and handles. This means both the part numbers and the drilling and installation procedures are always the same. The latest DUALSAFE series includes the addition of important functions, such as gasket compression adjustment and the internal safety handle.

Main benefits

- Opening either to the right or to the left or complete removal of the panel
- Gasket compression adjustment
- Safety system for doors with positive pressure
- Internal safety handle
- Less part numbers to manage in inventory
- Same drilling and installation procedure

Technical specifications

- Material - Nylon + fibreglass;
- Colours - black and grey (RAL 7035);
- Locking with key or hex screw.



Porthole

OBP*, OBP.Q*, OBPR*

Enginia's portholes respond to the need to inspect the most critical components, so as to ensure correct cleaning and maintenance. The latest generation portholes are fitted with LED lighting. Specifically developed for closed doors, these are used to inspect the inside of the unit, without the need for additional wiring. A cover is also provided to prevent algae from forming inside the humidifier module.

Main benefits

- Resistant to UV rays;
- Certified for hygiene applications;
- Easy assembly;
- Available with built-in light (optional on OBP.Q)

Technical specifications

- Round, square or rectangular;
- Available for panels from 25 to 60 mm
- Optional frame and cover (OBP.Q only)



Handles

MFG*

Enginia has developed a wide range of handles for a variety of different needs. Made from different materials, with closing by lock and key, hex screw or padlock, with plastic or aluminium grips, with fully external assembly i.e. without the need to drill holes in the panel, or with internal safety handle, with fixed or adjustable latch, suitable for panels from 25 to 100 mm, with grips in different lengths and weather resistant. Our engineers have designed these products to ensure easy assembly, without however neglecting the safety requirements in accordance with the latest regulations, making them highly requested by international AHU manufacturers.

Main benefits

Simple and economical solution versatile for single-flap modular systems, perfect tightness.

Technical specifications

- Grips up to 140 mm;
- Panel from 25 to 50 mm;
- Fixed or adjustable latch;
- with internal handle (140 series).

Other accessories



Unit joint



Bridge-type, compact panel locks



Bushing

The image features a close-up of copper coils on the left side, which are part of a direct expansion (DX) coil. The background is a dark, textured metal mesh. A red horizontal bar is positioned above the text area.

DX technology

Air handling units fitted with direct expansion coils represent an increasingly important innovation in this field. A refrigerant circuit equipped with variable-speed compressors can guarantee higher energy efficiency than any other technology available on the market, with better and more precise control of indoor temperature and humidity conditions compared to less advanced systems.

CAREL offers a wide range of technological solutions for optimum management of refrigerant circuits with electronic expansion valves and BLDC compressors, so as to ensure a significant increase in unit efficiency and a reduction in operating costs.



EEV technology

CAREL electronic expansion valves are designed to meet all cooling capacity requirements in the air conditioning and refrigeration sectors, and stand out in particular for their high-precision flow control, even at the lowest flow-rates. The standard CAREL ExV valve design process ensures high reliability over time, guaranteed by lifetime testing, and certifications in compliance with the main national and international standards.

One of the unique features of CAREL valves is perfect tightness to the refrigerant: despite the rotation of the motor, the valve member does not rotate when moving.

This allows the use of a high-quality Teflon gasket, which sits gently on the valve seat, without any sliding. To improve tightness even further, an elastic steel locking spring presses the valve member against the seat when the system is off: consequently, the motor can make a few more turns before stopping.

The energy accumulated by the spring in this phase means an increase in closing energy, giving tightness

values that are comparable to those of traditional solenoid valves. Finally, integration with CAREL controllers ensures extremely high precision, while the shape of the valve members not only also increases precision, but ensures equipercentile flow control.



Available on CPQ!

CAREL CPQ is the product selection and configuration tool designed to make the work of designers, customers and partners faster and simpler

Benefits

- Precise control
- Excellent tightness on closing
- Maximum reliability over time
- Wide range of models for cooling capacities up to 2000 kW
- Energy saving



E²V smart

E2V**Z

The low-capacity CAREL E2V electronic expansion valve for all applications with cooling capacity up to 40 kW. In the E2V smart version, the traditional benefits of CAREL valves are combined with the advantages of modularity (the valve can be dismantled) and the already renowned reliability and control quality of the hermetic E2V models.

In particular, the latest version, E2V-Z, can satisfy the needs of the most demanding HVAC/R applications, which nowadays require increasingly high-performance products, able to work in critical environments, with easy installation and simplified logistics management for OEMs.

This new type of construction means any size of cartridge can be fitted in the same valve body, thus allowing a quick change in cooling capacity by simply replacing the motor cartridge.



E³V and E⁴V

E3V*, E4V*

The E3V and E4V electronic expansion valves are CAREL's solutions for medium/high capacity cooling systems. E3V and E4V can work in both directions, representing the ideal solution for reverse-cycle applications as they simply the system by eliminating the need to install a solenoid valve and sight glass. Complete freedom of installation is ensured by the possibility to totally dismantle the various components: stator, motor block, sight glass. In particular, the E3V-Smart version joins the wide range of the E3V series with improved performance thanks to the new composite valve member, and the addition of a filter to protect the gasket. This solution offers a significant improvement in performance, as well as the ability to work at a refrigerant temperature up to 100 °C.

The innovative feature of the E4V is the built-in sight glass for monitoring the movement of the valve member and the flow of refrigerant in the circuit. Furthermore, the valve is made from modular elements assembled during installation, to simplify maintenance and inspection of the components.



EVD evolution

EVD*

The result of CAREL's extensive experience in electronic valve drivers, EVD evolution is available as a "single" and "twin" driver, the latter able to control two valves independently, using the most common refrigerants. Simple graphics and a series of LEDs allow an immediate overview of the operating status and main driver functions.

A powerful removable graphic display (EVDIS**0) can be used to configure the drivers, with clear and immediate status information and the possibility to enable control by selecting just four parameters:

- refrigerant used;
- valve model;
- type of pressure probe;
- application (chiller, refrigerated showcase, etc.).

EVD evolution works either in stand-alone mode, or connected to a pCO or boss supervisor.

EVD evolution can also manage control functions other than superheat, such as hot gas bypass, evaporation pressure control (EPR), control of valves for gas coolers in transcritical CO₂ circuits



Ultracap for EVD evolution

EVD0000UC0

Ultracap is the new emergency power supply module for electronic valves: it completes the EVDEvo, both single and twin, ensuring complete closure of the valves even in the event of sudden power failures.

By using ELDC technology (Electric Double Layer Capacitors), Ultracap can provide emergency power immediately, reliably and cleanly, representing a major step forward compared to conventional systems based on batteries, also as regards the disposal of materials used for maintenance.

Ultracap has been designed to provide 10 years of silent, reliable operation, without the hassle of periodic checks or battery replacement.

Ultracap means immediate energy: after just 5 minutes (4 with CAREL valves) from when power returns, it is already charged and ready to go again (basically the same time needed to restart the compressor...).

The extreme reliability of Ultracap, combined with the exceptional hermetic tightness of CAREL valves, eliminates the need for solenoid valves even in the most critical applications.

Ultracap can be connected to EVDEvo, as well as to all of the pCO5 family controllers, with truly simple installation, similar to a battery module.

Valve technical specifications table

Specifications	E2V smart	E3V and E4V
General		
Application limit pressures	<ul style="list-style-type: none"> maximum working pressure (MWP): 45 bars (653 psi) maximum operating pressure differential (MOPD): 35 bars (508 psi) PED: not applicable, Group 2 fluids, art. 3, par. 3 	<ul style="list-style-type: none"> maximum working pressure (MWP): 45 bars (653 psi) maximum operating pressure differential (MOPD): 35 bars (508 psi) E4V95 = 24 bars (349 psi) PED: E³V = not applicable, Group 2 fluids, art. 3, par. 3; E⁴V = Group 2, category 1 fluids
Operating conditions	<ul style="list-style-type: none"> refrigerant side: -40T70 °C installation environment: -30T70 °C 	<ul style="list-style-type: none"> refrigerant side: -40T70 °C installation environment: -30T70 °C
Ingress protection	IP67 – IP69k	IP67
Certification	UL and CE	UL and CE
Closing steps	500	500
Control steps	480	480

Driver technical specifications table

Specifications	EVD evolution	Ultracap for EVD
General		
Power supply	24 Vac 50/60 Hz, 24 Vdc (±15%)	24 Vac 50/60 Hz, 24 Vdc (±15%)
Operating conditions	-10T60 °C, 90% rH non-condensing	-25T50 °C, 90% rH non-condensing
Ingress protection	IP20	IP20
Certification	UL and CE	UL and CE
Assembly	DIN rail (4 modules)	DIN rail (4 modules)
Inputs and outputs	inputs: 2 digital, 2 NTC, 2 ratiometric outputs: 2 voltage-free contacts	inputs: 24 V outputs: 18.4 or 13 V
Serial ports	1	-
Dimensions	70x110x60 mm	70x110x60mm

Overview valves and drivers

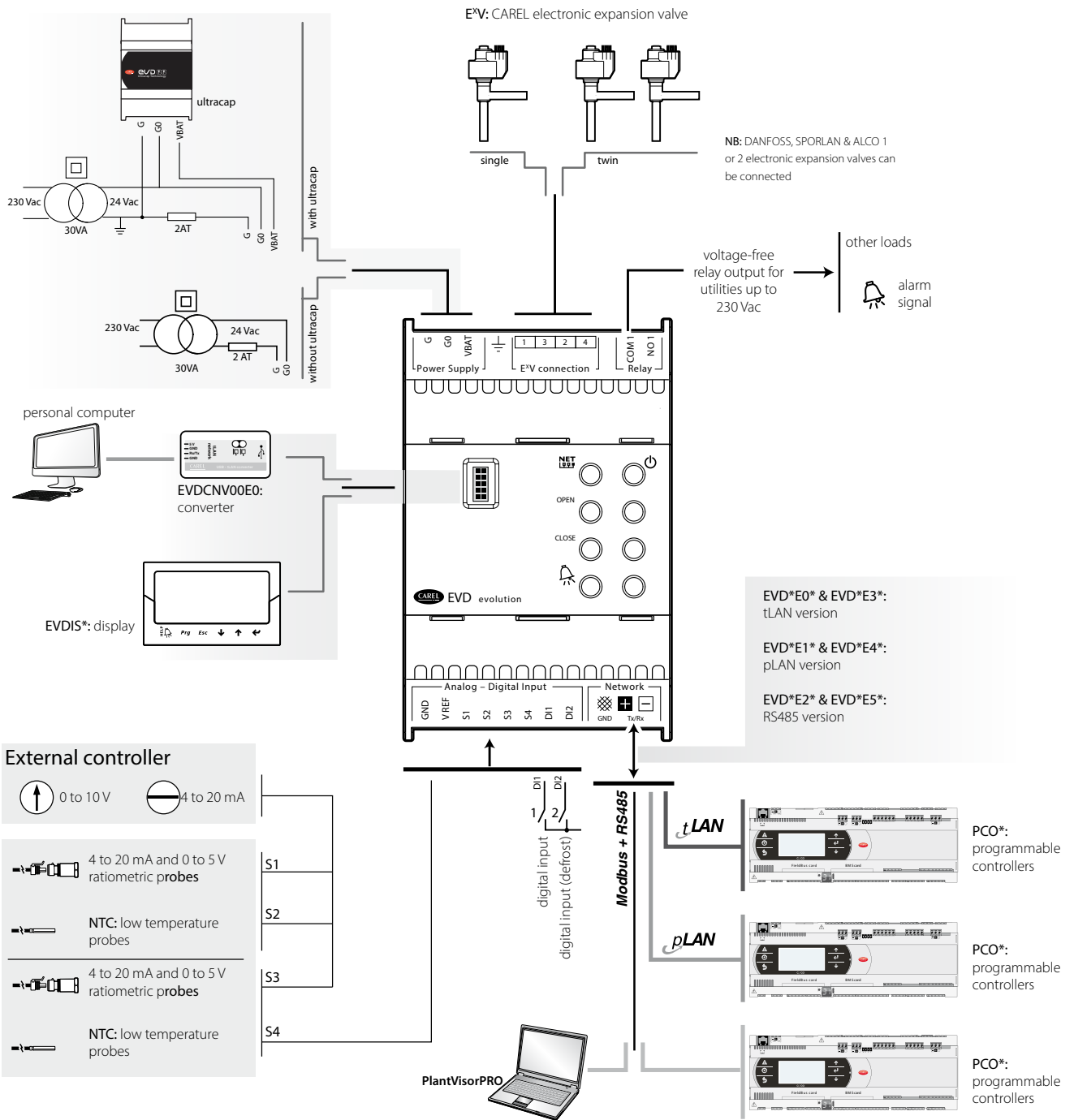



Outside condensing unit control

μChiller is the solution for complete management of air/water and water/water chillers and heat pumps with on-off and/or DC compressors.

uChiller has been designed with the focus on integration and connectivity: the serial communication options mean the main unit actuators can be managed more completely and reliably, optimising performance and efficiency, while NFC or Bluetooth connectivity enable interaction with the unit from mobile devices using the CAREL "APPLICA" app. APPLICA is designed to facilitate operations in the field, reducing risks and costs during commissioning and when managing the unit.

The range of models in fact includes wireless connectivity with NFC (Near Field Communication) as standard, as well as Bluetooth on dedicated models, allowing interaction with mobile devices using the CAREL "APPLICA" app, making it easier to configure parameters and commission the unit in the field.

The use of APPLICA represents a substantial novelty in the evolution of CAREL controllers. In fact with APPLICA the unit can be configured in one single

operation, exchanging information with a remote service and receiving alerts in the event of alarms. Moreover, when new features become available on the market, the app can be simply updated to guarantee service continuity, even on units that have already been installed. The APPLICA application is available on Google Play for devices with Android operating system.



Available on CPQ!

CAREL CPQ is the product selection and configuration tool designed to make the work of designers, customers and partners faster and simpler

Benefits

- Usability;
- Efficiency and reliability;
- Wireless connectivity with APPLICA;
- Refrigerants: compatibility with natural refrigerants and low GWP blends as per F-Gas, EPA, ...

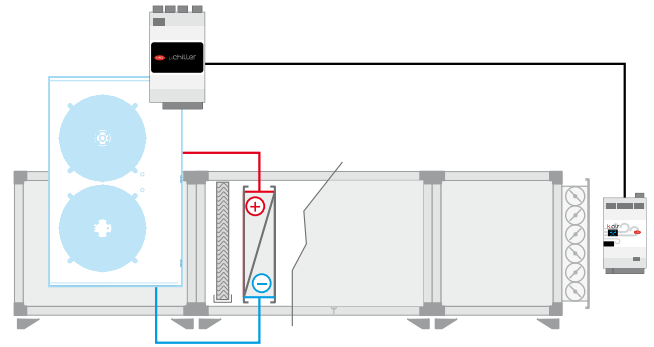

μChiller

UCHB*

μChiller is the solution for complete management of air/water and water/water chillers and heat pumps with on-off and/or DC compressors. The maximum configuration manages 2 compressors per circuit with up to 2 circuits (using the I/O expansion for the second circuit).

The product is available in panel and DIN rail versions, according to user needs.

With serial communication available across the entire family of controllers, the main unit actuators (electronic expansion valve, fan controller, compressor inverter, etc.) can be managed to optimise unit control and efficiency.

Furthermore, μChiller can be integrated into higher level control systems via the BMS port, thus creating a modular management solution for an entire system, from heating/cooling to fluid distribution.

The distinctive element of the product is complete control of high-efficiency units through integrated management of devices such as electronic expansion valves and brushless DC compressors. This ensures greater compressor protection and reliability and, at the same time, high unit efficiency. The application features more than 50 models of BLDC compressors by different manufacturers, all tested and certified by CAREL in its laboratories.

μChiller provides complete control of the compressor envelope at different frequencies, with the aim of guaranteeing compressor operation in ideal conditions, thus ensuring maximum reliability.

The range of models in fact includes wireless connectivity with NFC (Near Field Communication) as standard, as well as Bluetooth on dedicated models, allowing interaction with mobile devices using the CAREL "APPLICA" app, making it easier to configure parameters and commission the unit in the field.

In fact with APPLICA the unit can be configured in one single operation, exchanging information with a remote service and receiving alerts in the event of alarms.

Technical specifications

Power supply: 24 Vac/dc, +10%-15%; 50/60 Hz

Operating conditions -20T60 °C, <90% rH non-condensing

Power consumption: for transformer sizing

Ingress protection:

- IP20 (rear, panel model)
- IP65 (front, panel model)
- IP00 (DIN model)

Panel and DIN without ExV valve driver: 15 VA

DIN with ExV valve driver: 30 VA

Mounting:

- UCHBP*: panel models;
- UCHBD*: DIN rail models

Software class and structure: A

User interface/buzzer Panel: built-in

DIN: not included on the controller, built-in on the user terminal

Display: LED 2 rows, decimal point, and multi-function icons

Connectivity

- NFC Max distance 10 mm, variable according to the mobile device used
- Bluetooth Low Energy Max distance 10 m, variable according to the mobile device used
- BMS serial interface Modbus over RS485, not opto-isolated
- Fieldbus serial interface Modbus over RS485, not opto-isolated
- HMI interface Modbus over RS485, not opto-isolated



Inverters

Inverters are one of the most cutting-edge solutions for energy saving. Their correct application ensures considerable energy saving, as well as improvement in operation of all of the unit's components.

Compressors with permanent magnet motors controlled by a DC inverter are the heart of the most efficient technologies available for HVAC/R applications. CAREL has introduced this technology in refrigeration and air conditioning applications, especially those that consume the most energy, such as heat pumps, air conditioners for data centres, etc.

With the power+ range, CAREL offers an inverter specifically designed to control compressors with BLDC/BLAC permanent magnet motors. Integrated into the CAREL controller, the inverter ensures significant energy savings by modulating the compressor speed and consequently unit cooling capacity. The benefits? The results are amazing:

- energy consumption reduced by up to 40%;
- fine and constant temperature control;
- optimisation of operating conditions to maximise compressor reliability and performance.

Variations in load are managed precisely and with constant control of the compressor envelope. This brings considerable increases in unit COP during part load operation, resulting in higher Seasonal Performance Factor values.

In addition, CAREL also supplies general-purpose inverters for AC motors. AC inverters are the most flexible and consolidated solution for managing any component equipped with a variable-speed AC motor (fans, pumps and compressors). The inverter can reduce the motor speed and consequently power consumption when maximum capacity is not needed.

Benefits

- Energy saving;
- Unit rotation;
- Higher performance.



DC inverters: power+

PSD*

power+ is an inverter specifically designed to control compressors with BLDC/BLAC permanent magnet motors. Integrated into the c.pCO sistema, this ensures significant energy savings by modulating the compressor speed and consequently unit cooling capacity.

The in-built features on power+ are focused on driving compressors:

- programmable acceleration ramp with steps, so as to meet the needs of all applications;
- a PTC input for compressor thermal protection. power+ also has an STO (Safe Torque Off) safety input, which can be used to cut-off power to the compressor in the event of an emergency, for example following activation of a high pressure switch.

Furthermore, power+ can intelligently manage the compressor in extreme conditions: algorithms to automatically reduce switching frequency or rotation speed are available to avoid the compressor stopping in high temperature conditions.

Installation of the product is facilitated by the flat design of the electronics, as well as the availability of removable fixing brackets. The heatsink needed to dissipate heat in ambient temperatures up to 60 °C

can be placed at the rear of the panel, thus greatly reducing the space occupied inside the electric panel.

The gasket provided guarantees IP44 protection on the heatsink side.

power+ has been tested with most of the BLDC compressors available on the market: SCI (Siam Compressor Industries), Samsung, Hitachi, Toshiba. power+ can be configured for a BLDC compressor tested by CAREL at a simple click, if used together with the c.pCO series controllers. The CAREL controller not only sets the electrical parameters on power+, but also provides complete thermodynamic control of the compressor, based on the specifications of the compressor manufacturer.

Technical specifications

Power supply:

- single-phase: 200-240 V 12, 15-18, 25-30 A;
- three-phase: 380-415 V 380-480 V 18-24 A, PSD1 35-40 A, PSD2 60 A

Operating conditions: 60 °C 95% rH non-condensing

Ingress protection: IP20/IP44

Certification: CE, UL

Mounting: panel or semi-recessed

Serial ports: RS485/Modbus®

Connections: screw terminals



AC inverters

VFD*

The frequency converter for AC applications is CAREL's most flexible solution for managing thermodynamic circuits with variable flow-rates: an inverter capable of controlling the rotation speed of traditional AC induction motors. Speed modulation allows devices such as fans, pumps and compressors to adapt their output according to the instant load request, thus ensuring both best control of the system and lower energy consumption.

CAREL has a wide range of products available for every need, from single-phase to three-phase power supply, in a variety of sizes: from 0.37 to 75 kW. In addition, all products come with a built-in display, IP20 and IP55 ingress protection for the same size. A new smarter and more compact solution, which can easily adapt even to the most extreme environments, thanks to a special resin treatment on the PCB and a working temperature range extending above 50°*.

The application for air handling units offers:

- fan speed control to maintain a constant pressure level in centralised ventilation systems. Ideal for retrofits;
- easy implementation with ready-to-go c.suite functional block.

Technical specifications

Power supply:

- single-phase: 200-240 V 50/60 Hz;
- three-phase: 380/480 V 50/60 Hz;

Operating conditions: -20T50 °C

Ingress protection: IP20/IP55

Certification: CE, UL

Output current: 1.8 A-150 A

Safety: STO SIL2

EMC filter: Included for class C2

Communication: Modbus RTU RS485

Display: included

Part number

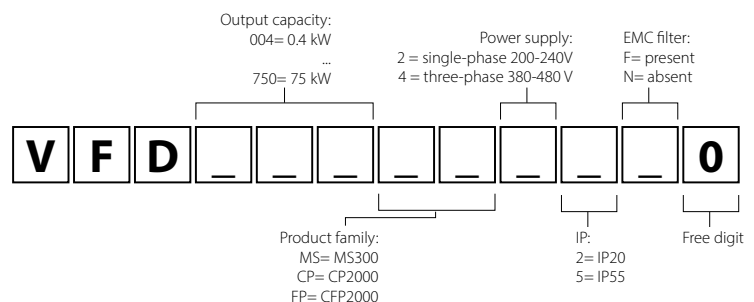





Electrical panels

Electrical panels for air handling units are the result of CAREL's extensive experience in supplying complete solutions for HVAC. They represent the link between the control system and the final application. Our electrical panels are available as either ready-made or custom solutions, and are always built following standardised and tested processes, using components supplied by the world's leading brands so as to guarantee the highest quality and reliability.



Electrical panels for air handling units

Ever since it was founded, CAREL has offered its customers the design and production of electrical panels for HVAC/R applications.

power solutions is the upgraded offering of integrated power devices, with the focus on energy saving through the high-tech contents of CAREL's products.

power solutions is the perfect completion of every CAREL product, the link between the control system made up of electronics and software, and the final application.

CAREL is thus even closer to its customers, offering them additional benefits in terms of logistics flow; customers will no longer need to outsource the power devices and the wiring operations.

CAREL therefore offers a complete solution, ready for installation on the production line or on site.

The support and advice you need are always close at hand; we speak your language, and will be able to help you quickly choose the final solution with the utmost professionalism.

CAREL offers various different solutions for air handling units, both standard for units of low technological complexity, and custom solutions designed specifically to meet the customer's detailed requirements.

Benefits

- Application know-how;
- Reliability;
- Faster installation times;
- Tested and certified solutions.



Standard and custom solutions

KA*, CM*

Standard panels are suitable for managing air handling units with the combinations covered by the k.Air parametric control solutions. Standard electrical panels can manage and power two fans, external electrical loads and actuators, valves, probes, alarms and safety devices, limited to the number of inputs and outputs available on the electronic controller. The solution is mounted inside a two-door fibreglass enclosure (one of the doors is transparent), suitable for installations from -25 to 60 °C, has high strength and impact resistance (IK10), 650 °C glow wire flammability, IP65 protection and RAL 7035 grey finish, with IMQ CEI 23-48/23-49 and IMQ EN 62208 certifications. Each enclosure comes with its own wall installation kit with threaded holes already prepared on the bottom. The main panel disconnect switch is positioned on the inside door, with control from the front via a rotary

handle. The user interface is located on the inside door and can be chosen between a traditional 6-button LCD display or a more advanced 4.3" colour touchscreen interface. The panel is supplied with all inputs and outputs already connected to the terminal block, so as to be able to fully exploit the potential of the control solution. In addition to the detailed wiring diagram, supplied as standard in paper form, a further quick wiring diagram is available printed on glossy adhesive paper and placed on the rear of the inside door.

Starting from the standard solutions, CAREL can also supply custom based on the specific needs of each individual customer. The custom solutions can combine power to different loads, such as circulating pumps, electric heaters, additional fans, etc. on the same device, have different user interfaces or signalling devices, and even custom aesthetic or assembly options. Through

its extensive worldwide network, CAREL can analyse your requirements, size and choose the best components and draw up the necessary technical documentation.

Technical specifications

Power supply: 230V 1PH+N/ 400V 3PH+N, 50/60Hz

Operating conditions: -10T40°C, 90% rH non-condensing

Material: Polyester, with two transparent doors

Colour: RAL 7035

Ingress protection: IP 55

Fan power: max 30 kW 55 A

Secondary circuit voltage: 24 Vac or 230 Vac

General protection: door interlock disconnect switch

Theoretical diagram

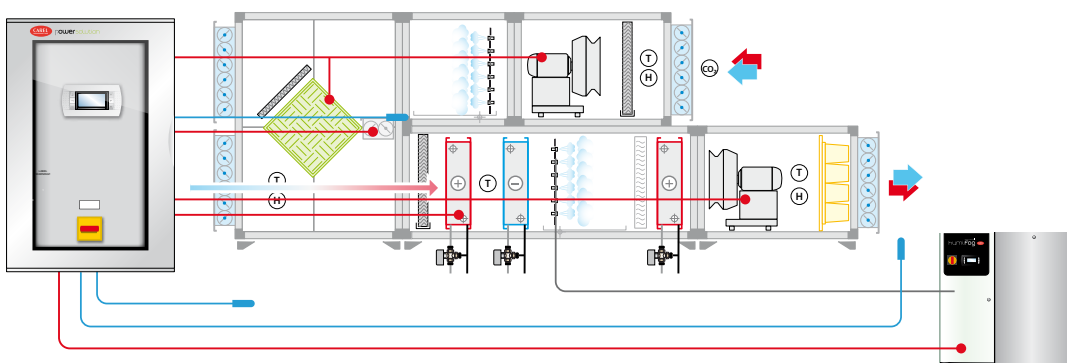



Remote management systems and digital services

Optimised management of an air handling unit requires the use of a control, monitoring and supervisory package for the entire system. Complete control of the devices managed, ease of use, sophisticated configurations for alarm notification and data analysis tools make CAREL supervisors the best solution in terms of reliability, IT security and energy saving.



Remote management systems and digital services

Monitoring, supervisory and remote control are essential requirements for HVAC systems. Having the possibility to access your system conveniently from a laptop or mobile device, acquire information on operation and alarms, and set parameters, all through an attractive interface accessible to all users, is fundamental for making the system more efficient and optimise routine maintenance and service. Moreover, the standards in force and the trend towards energy saving make these systems a key to success and differentiation.

The digital transformation is now underway, and digital services are growing in importance in the HVAC sector, creating new opportunities and challenges. CAREL's range of digital services enable the transformation of HVAC applications. They are focused on reducing costs, optimising maintenance and energy consumption, and on improving the performance of both individual units and complex systems. By integrating many years of thermodynamic expertise with IoT technologies, CAREL makes remote management of systems simple, secure and effective. CAREL supports this development by providing field devices equipped with RS485 and/or Ethernet interfaces for plug-n-play connection

to local and centralised supervisory systems and services, such as the Boss local supervisor: this allows the entire system to be controlled using custom interfaces, even via mobile devices, with up to 300 devices in each system. Our extensive digital portfolio includes customisable apps for interacting with units, cloud portals for remote control of systems and in-depth data analysis tools (Analytics) using AI technologies (machine learning algorithms) for continuous improvement of units and systems.

Benefits

- **plug & play:** complete, readily-available solution.
- **scalable:** modular infrastructures to adapt to different needs
- **integration:** everything is perfectly integrated into the CAREL control system, to make management simple and immediate



Digital services for air handling units

The CAREL Cloud platforms, by collecting and processing data from the supervisory systems installed on site, offer a single structured database with information and indicators (KPI) for different types of users with specific needs.

Remote supervision via by CAREL digital portals can be organised:

- **By asset:** remote management of units with an aggregate view of every single unit installed worldwide
- **By site:** complete management of an entire system, with an aggregate view of all systems installed worldwide

Furthermore, the ability to set various access profiles means specific functions can be made available for the following types of users:

Service personnel

Responsible for maintenance and focused on troubleshooting, through:

- System dashboard (where available)
- Viewing and acknowledging alarms in real time
- Alarm notifications
- Geolocation
- Historical data analysis and graphic trends
- Report scheduling
- Emulation and remote interaction with the unit terminal (PGD1) for c.pCO programmable controllers
- Remote software updates on the connected units

Manufacturer (OEM)

Can exploit all the features of the Service profile to optimise maintenance and related costs. Benefits from additional tools to interpret performance and overall efficiency across the entire product life cycle, while at the same time understanding how to improve performance over time:

- Statistics for analysis of and comparison between systems based on alarms, energy consumption, air quality, etc.
- Dashboards and reports to monitor energy efficiency, control performance, etc.
- Analysis and attribution of maintenance tasks to the service network

End user of the product

Requires basic unit control, with access to:

- System dashboard for display (where available);
- Read and write specific variables in real time;
- View specific alarms in real time;
- Remote access via dedicated app (where implemented, for asset management only).

Carel digital solutions are also available in the Preset option, which includes:

- Access to the cloud platform;
- Support for management and configuration of portal systems.

Depending on the chosen digital platform, dedicated supervisory gateways (or Edge servers) are available. When installed on site and connected to

the cloud, these offer various connection options for the products or systems being monitored:

- For single units or small networks: Cloudgate family devices
- For HVAC/REF systems: Boss family devices

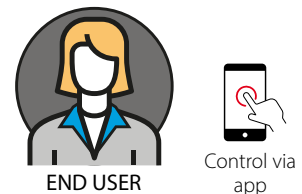
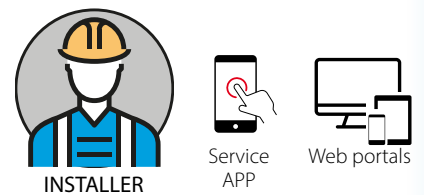
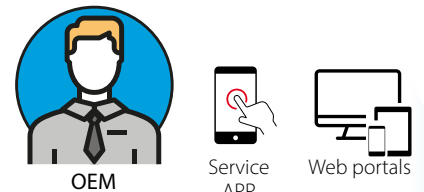

Optimised transport

Asset management

Code	Description
-00SRD01*	tDisplay 1 year Ethernet/4G
-00SRS01*	tService 1 year Ethernet/4G
-00SRT01*	tAnalytics 1 year Ethernet/4G
-00SRTV01*	TSERVICE Preset Ethernet/4G FEE 1 YEAR
-00SRU01*	BUNDLE TDISPLAY + TSERVICE + TANALYTICS Preset Ethernet/4G FEE 1 YEAR

*: replace the asterisk with: 0=Ethernet; 1= 4G Area 1 (note 1); 2= 4G Area 2 (note 1); 3= 4G Area 3 (note 1)

1: Area1 subscriptions refer to the EMEA region, Area2 subscriptions refer to the North America and Australia, Area3 subscriptions refer to the APAC region. For details of the coverage in individual countries, see to the tERA General Terms and Conditions of Sale. For subscription durations other than one year, contact your sales representative (excluding Preset option).

Sytem management

Code	Description
9SPBR**Y10	RED optimise Retailer Bundle Small/Medium/Large/ExtraLarge: 1 YEAR fee per Store 2
9SPBC**Y10	RED optimise Contractor Bundle Small/Medium/Large/Extralarge: 1 YEAR fee per Store 2
9SPPC00Y10	RED optimise Preset Contractor Bundle: 1 year fee per store
9SPPR00Y10	RED optimise Preset Retailer Bundle: 1 year fee per store

*: replace the asterisk with: 0L: system large (note 2); 0M: system medium (note 2); 0S: system small (note 2); 0X: system extra large (note 2)

2: the system size is defined as follows: SMALL (S) for systems with up to 15 control devices in the field, MEDIUM (M) for systems with up to 50 control devices in the field, LARGE (L) for systems with up to 100 control devices in the field, EXTRALARGE (X) for systems with up to 300 control devices in the field. Maximum of 50 systems managed with the Preset option.

Values:

- Consultancy
- Installation & Configuration
- Commissioning
- Planned Maintenance
- Unscheduled Maintenance
- Remote Control
- Preventive & Prescriptive Maintenance

Advanced user interface

Parameters and variables

Geolocation

Alarms and notifications

Commissioning and service

KPIs and reports

boss technical specifications table



boss

BM*

boss is the new CAREL local supervisor for medium and large systems with built-in WiFi and accessible from all mobile devices.

The boss pages feature a responsive design and thus can be accessed from a mobile device for both programming and everyday tasks.

These adapt automatically their graphics to the device they are displayed on (computer with different screen resolutions, tablets, smartphones), minimising the need for the user to resize pages and scroll through the contents.

For the first time on a CAREL supervisor, boss also includes the BACnet protocol, the leader in HVAC supervisory applications. It includes boss-micro, for small installations of up to 15 devices, and boss-mini, suitable for medium-sized applications up to 50 devices. For larger and more complex installations, boss integrates up to 300 devices.

Dimensions

boss

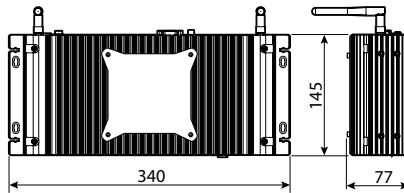

boss mini

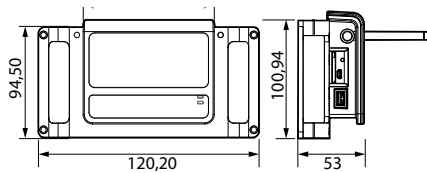

boss micro

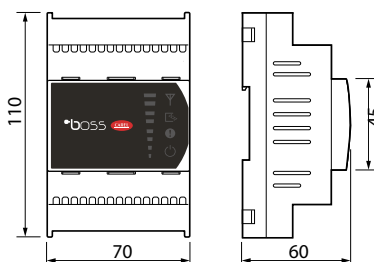

Functions	
Hardware	
Integrated Wi-Fi connectivity to mobile devices	
Video output	
Double Ethernet port (separation of LAN/Internet connections)	
Integrated backup memory expansion	
Embedded RS485 ports	
Integrated digital input	
Temporary IP address / reset button	
Integrated digital outputs	
USB host ports	
Status LEDs	
Possibility to connect external USB peripherals	
Power supply	
Software	
Minimum variable sampling time	
Maximum number of devices and variables that can be logged	
All pages responsive	
Graphic customisation with HTML5 / SVG technology (using c.web tool)	
Web connection with encrypted protocol (HTTPS)	
Third-party device integration	
Modbus TCP/IP / RTU client protocol	
Data synchronisation with RemotePRO	
BACnet client Protocol (MSTP and TCP/IP)	
BACnet server Protocol (TCP/IP)	
Modbus RTU or TCP/IP server protocol	
XML server protocol	
XML push protocol	
SNMP Manager protocol	
MQTT protocol:	
SNMP Agent protocol	
Custom logic development by customer	
Logical devices / logical variables	
Performance index (cost 1 plug-in credit)	
Energy consumption control and management	
Suction pressure optimisation	
Parameter control (cost 1 plug-in credit)	
Compressor rack safe restart (cost 1 plug-in credit)	
Dew point broadcast	
HVAC unit free cooling optimisation	
Air-conditioning on/off optimisation	
Optimised lighting management based on outside light	
Optimised unit capacity management (cost 1 plug-in credit)	
Max. number of extra functions that can be enabled (plug-ins)	
Send email	
Send instant messages (Telegram)	
Send SMS	
Manual and/or automatic reports in CSV and PDF format	
Scheduled activity management	
Languages available	

boss (BMHS****0)	boss-mini (BMEST****0)	boss-micro (BMBST****0)
YES	YES (depending on the model)	
VGA/Display Port	micro HDMI (depending on the model)	NO
	Yes	
Yes (uSD)	YES already inserted in BMEST**LE0 models	Yes (uSD)
2 opto-isolated	1 opto-isolated; 1 not opto-isolated	1 opto-isolated ; 1 not opto-isolated
Yes	NO	Yes
NO	Yes	Yes
3 relays with changeover contacts N.O./N.C.	3 voltage outputs 24 Vdc	2 voltage outputs 24 Vdc
6 (2 front and 4 rear)	1	1
8 front (status and I/O)	2 front (status)	8 front (status, I/O, wireless signal)
Yes		NO (not necessary)
100-240V ~ 50-60Hz (power supply module input)	24 Vdc	24 Vac/Vdc
5 sec	30 sec	30 sec
300/3500	50/500	15/150
	Yes	
	Yes	
	Yes	
	Yes (using device creator tool)	
	Yes	
	Yes (cost 1 plug-in credit)	
	Yes (cost 1 plug-in credit)	
	Yes (cost 1 plug-in credit)	
	Yes (cost 1 plug-in credit)	
	Yes (cost 1 plug-in credit)	
	Yes	
	Yes	
	Yes	
	Yes	
	Yes (cost 1 plug-in credit)	
	Yes (cost 1 plug-in credit)	
Yes	Yes	NO
	Yes (cost 1 plug-in credit)	
	Yes (cost 1 plug-in credit)	
Yes	Yes	NO
Yes	Yes	NO
	Yes (cost 1 plug-in credit)	
	Yes (cost 1 plug-in credit)	
	Yes (cost 1 plug-in credit)	
	Yes (cost 1 plug-in credit)	
Yes		
20	4	2
	Yes	
	Yes	
	Yes	
	Yes	
	Yes	

Italian, English, German, French, Spanish, Portuguese, Russian, Turkish, Chinese, Polish, Danish, Swedish, Japanese, Hungarian, Dutch, Korean



APPLICA



CONTROLLA



CloudGate

GTW*

The Cloudgate family gateways have been designed to remotely connect and monitor HVAC/R units that are typically not managed locally and not connected to the supervisory system in the building where they are installed. The various models differ in terms of connectivity to field devices and the cloud, so as to adapt to all the types of applications that the the connected HVAC/R unit needs to be controlled for, either read-only (e.g. reading temperatures or alarms) or direct interaction (e.g. change the operating temperature). All of these possibilities to interact with the units connected to CloudGate are made available using the CAREL tERA cloud platform services.

Part number	Description
GTW000TWB0	Cloudgate Ethernet
GTW000TFA0	Cloudgate WiFi
GTW000T2G0	Cloudgate Mobile 2G
GTW000T4*0	Cloudgate Mobile 4G

* to be defined based on the location of the installation site

Mobile apps

APPLICA and CONTROL are the new apps developed by CAREL for interacting with the latest-generation CAREL controllers. APPLICA and CONTROLLA have been developed using a unique approach: rather than different versions for each device, there is just one app for all compatible CAREL devices.

APPLICA has been developed to revolutionise and simplify the commissioning and maintenance of HVAC/R units, CONTROLLA to provide end users with a simple and customised unit interface. Both apps are available for Android and iOS devices and can be downloaded for free from the corresponding app stores.

Services included:

APPLICA and CONTROLLA come with the following features:

- Unit-specific user interface;
- Write parameters/read variables;
- Alarm management;
- Profiled access with username and password;
- Local connection to compatible CAREL devices via NFC or Bluetooth protocols;
- Remote connection to compatible CAREL devices via the tERA portal (CONTROLLA only).

APPLICA comes with the following features:

- Historical and real-time graphs;
- Create and set configurations/cloning;
- Automatically save configurations/cloning to the cloud;
- Set device date/time;
- Firmware update (where featured via wireless);
- Unit documentation.

Benefits:

- Simple and clear user interface;
- One single APP for all compatible CAREL controllers;
- Profiled access to unit parameters;
- NFC, BLE and WiFi wireless connectivity.

Headquarters

CAREL INDUSTRIES HQs
Via dell'Industria, 11
35020 Brugine - Padova (Italy)
carel@carel.com



Authorized distributor

Arion S.r.l.

Sede operativa:
Via Pizzo Camino, 28
24060 Chiuduno (BG) - Italy
www.arionsensors.com

C.R.C. S.r.l.

Via Selva di Pescarola 12/9
40131 Bologna - Italy
info@crc-srl.net
www.carel.com

ENGINIA S.r.l.

Viale Lombardia, 78
20056 Trezzo Sull'Adda (MI) - Italy
www.enginiasrl.com

HygroMatik GmbH

Lise-Meitner-Straße 3
24558 Henstedt-Ulzburg - Germany
www.hygromatik.com

Klingenburg GmbH

Brüsseler Str. 7
45968 Gladbeck - Germany
www.klingenburg.de

Klingenburg International Sp. z o.o.

ul. Metalowców 5
PL-58-100 Świdnica, Poland
www.klingenburg.pl

RECUPERATOR

Via Valfurva 13
20027 Rescaldina (MI) - Italy
www.recuperator.eu

Sauber

Via Don Doride Bertoldi, 51
46047 Porto Mantovano (MN) - Italy
www.sauberservizi.it

Senva

1825 NW 167th Pl, Beaverton,
OR 97006, Stati Uniti
www.senvainc.com

CAREL

To the best of CAREL INDUSTRIES S.p.A. knowledge and belief, the information contained herein is accurate and reliable as of the date of publication. However, CAREL INDUSTRIES S.p.A. does not assume any liability whatsoever for the accuracy and completeness of the information presented without guarantee or responsibility of any kind and makes no representation or warranty, either expressed or implied. A number of factors may affect the performance of any products used in conjunction with user's materials all of which must be taken into account by the user in producing or using the products. The user should not assume that all necessary data for the proper evaluation of these products are contained herein and is responsible for the appropriate, safe and legal use, processing and handling of CAREL's products. The information provided herein does not relieve the user from the responsibility of carrying out its own tests, and the user assumes all risks and liabilities related to the use of the products and/or information contained herein. © 2023 CAREL INDUSTRIES S.p.A. All rights reserved.